

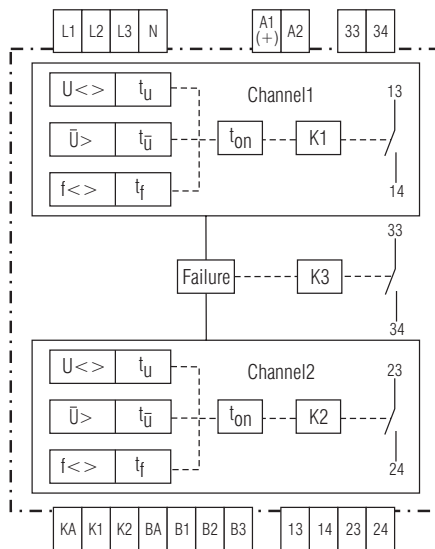

Product Description

The voltage and frequency monitor RP 9811 represents a solution to monitor mains supply when feeding power to a public grid. User-friendly: The unit can be adjusted quickly and simply with only two rotary switches. Use the first rotary switch to select one of the already preset standards according to your national requirements. Use the second rotary switch to set the type of system, quickly and simply, on the unit. You can adjust each parameter individually with menu-guidance in case of different requirements. All measuring variables required are constantly determined by the unit. If incorrect voltage or frequency values occur, the RP 9811 disconnects the distributed power generation system securely from the mains.

Circuit Diagram



M10900_e

Connection Terminals

Terminal designation	Signal description
A1(+), A2	Auxiliary voltage AC or DC
L1, L2, L3, N	Connections for measuring circuit
KA, K1, K2	Feedback circuit of external section switch KA / K1: Section switch 1 KA / K2: Section switch 2
BA; B1, B2, B3	Enabling of monitoring function: BA / B1 + BA / B2 bridged) + BA / B3 open With setting standard CEI 0-21:2012-06: BA / B2 - function selection
K1 (13, 14)	Connection section switch 1 - NO contact
K2 (23, 24)	Connection section switch 2 - NO contact
K3 (33, 34)	Fault indicating relay - NO contact (open NO: Indicates fault)

Your Advantages

- Mains and system protection for your generator set
- Can be used in several countries
 - DIN VDE 0126-1-1:2013-08 (generator sets on public grid)
 - VDE-AR-N 4105:2011-08 (generator sets on public grid)
 - BDEW-directive:2008-06 (generator sets on medium voltage grid)
 - CEI 0-21:2012-06 (generator sets in Italy)
 - ÖVE/ÖNORM E8001-4-712:2009 (generator sets in Austria)
 - G59/3 (generator sets in UK)
- Easy adjustment via rotational switch and menu display
- Indication, diagnostics and fault presentation via display and LEDs
- Password protected
- Protection against manipulation by sealable transparent cover over setting switches
- CRC-value for parameter testing
- Adjustment of the voltage for nominal voltage will change the limit values accordingly
- Mains synchronization on generator operation

Features

- According to DIN EN 60255-1
- Can be used according to EEG 2012 and SysStabV
- Voltage and frequency monitoring for generator sets
- Fail-safe 2-channel structure
- Monitoring of the section switches by measuring the response time
- System test via test button
- Enabling inputs allow integration into various ripple control and plant concepts
- Isolated grid detection
- Manual reset
- Memorising of disconnection time
- Connection or re-connection after adjustable delay time t_{on}
- Factory setting according to:
 - VDE-AR-N 4105:2011-08, DIN VDE 0126-1-1:2013-08,
 - BDEW-directive:2008-06, CEI 0-21:2012-06,
 - ÖVE/ÖNORM E8001-4-712:2009, G59/3 LV
- Random controlled disconnection in the range of 50.2 Hz and 51.5 Hz for non-regulated power generation systems
- Random operated connection time (t_{on}) setting range 60 ... 600 s
- Additional fault signalling relay output
- High measuring accuracy
- Installation type enclosure 4TE (width x height x depth: 70 x 90 x 71 mm)

Approvals and Markings



Applications

- Monitoring of voltage and frequency for generator sets e.g.:
- Photovoltaic
 - Wind power
 - Water power
 - Combined heat and power stations

Functions

The voltage and frequency module RP 9811 monitors the domestic generator set and the mains of the energy supplier. It is built up in a redundant way and each of the 2 channels act on a separate output relay. The adjustment is made via menu and rotational switches. The factory default setting is set by rotational switch and can be set via menu. After setup the settings can be sealed with a transparent front cover or alternatively protected by password.

Measured values above or below the limits will lead to a disconnection of the generator system from the mains. The reconnection of the generator system to the mains is only enabled, when the frequency and the voltage are within the limits for the adjusted time t_{on} without interruption.

The voltage frequency monitor RP 9811 measures the voltage in all 3 phases between phase and neutral. Depending on the rotary switch setting the phase-to-phase voltages are calculated and monitored. The frequency is measured single phase in both models on L1.

The operating state, measured values, error memory and the parameters are viewed via LCD display. The measured value, operating data or scan of the error memory is selected via the "Mode" button, the parameters are selected via the "RUN/SET" button. Status LEDs are available also.

Parameter No. 25 short interruption ($t_{onShort}$) = on:

After the disconnection due to a short interruption < 3 s, reconnection automatically occurs if the mains frequency and voltage have been continuously within the tolerance range for 5 s. A short term interruption does not register as a hard failure of the operating voltage.

Changing the mains rated voltage – limit values adjust automatically:

If the mains voltage must be adjusted because of the requirements of the power supply utility or if the operation of the voltage and frequency monitor takes place on a medium-voltage grid, parameter 1 (rated voltage U_N) must be adjusted accordingly. With a medium-voltage grid, this is due to the transformation ratio of the voltage measuring transducer used through which the device is connected to the grid.

The voltage-related monitoring parameters are set as percentage deviation of the mains rated voltage. When the mains rated voltage changes, the absolute limits adjust automatically to the changed mains rated voltage.

Functions

Function RoCoF (df/dt)

RoCoF „Rate of Change of Frequency“ (rate of Change of Frequency)

Parameter:

Parameter table

	Display	Value	
1)	RoCoF	0.10 ... 5 Hz /s / off	df / dt
2)	T_df/dt	0.05 ... 10 s / off	off delay
3)	Perio	4 ... 50	Number of cycles for measurement
Default- setting: 4 cycles			

Description

The voltage and frequency monitor RP 9811 is able to measure the rate of change of frequency df/dt (frequency gradient). If the frequency gradient rises for an adjustable time over an adjustable value the RP 9811 switches off after an adjustable time.

The frequency gradient can be positive or negative, i.e. rising frequency as well as dropping frequency can be detected.

Response

If for the duration of the selected number of cycles the frequency gradient is exceeded, the adjusted time delay „T_df/dt“ is started, the display shows the failure message „RoCoF“ and the fault signaling relay switches.

If the failure gradient goes under the response value minus hysteresis of 5 % within the selected number of cycles or the direction of change of frequency changes the monitoring cycle starts again from the beginning.

Only when the time delay „T_df/dt“ is finished the RP 9811 switches off. If „T_df/dt“ = off the RP9811 switches off immediately.

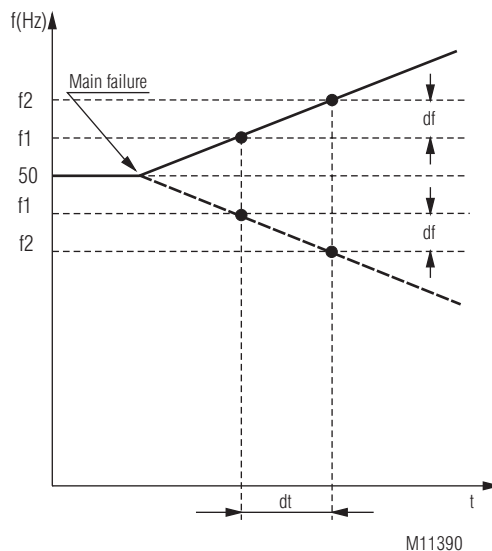

Function Vector shift

Parameter:

Parameter table

1)	VecSh	2 ... 20 °C / off	(Vector shift)
2)	Phase	1 / 3	(Single- oder 3-phase)

Description

The add-on fast disconnection on vector shift detects phase jumps in all 3 phases simultaneously. Independent of this the unit can be set to react on single phase vector shift (sensitive measurement).

The selection is done with parameter "Phase" number of phases 1 or 3 phases. When selecting 3 phases the vector shift response takes only place when the adjusted vector shift angle is exceeded in all 3 phases.

The shift angle can be adjusted between 2 and 20 %. The value could be positive or negative. The actual frequency is continuously measured in all 3 phases. The measurement is based on time measurements of full frequency cycles and is calculated as mean value of 8 cycles before a vector shift. To detect a vector shift the sum of two cycles is relevant. After each cycle a new sum is calculated. A angle shift that has the length of 2 cycles is reliably detected.

Response

When detecting a vector shift the RP 9811 disconnects within < 50 ms.

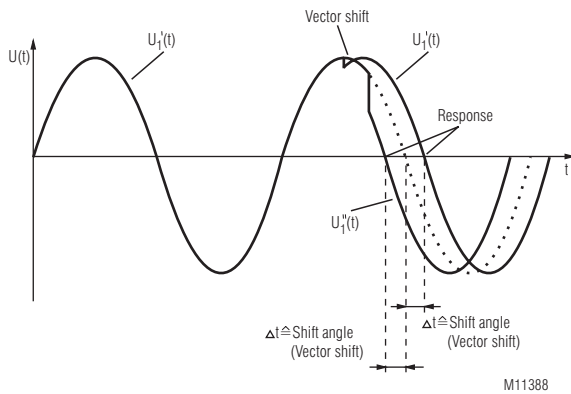

Reset

If a disconnection was caused by the functions „vector shift“ or „RoCoF“ the reset is started after a delay of 5 seconds. The adjustable reset time “tON” elapses. To start the reset the mains must be without fault and the monitoring function is enabled (inputs BA/B1, B2, B3).

Application

The functions „RoCoF“ and vector shift are mainly used in generator operation. See also Application example „Generator operation with mains synchronization,“ in the data sheet.

Indicators

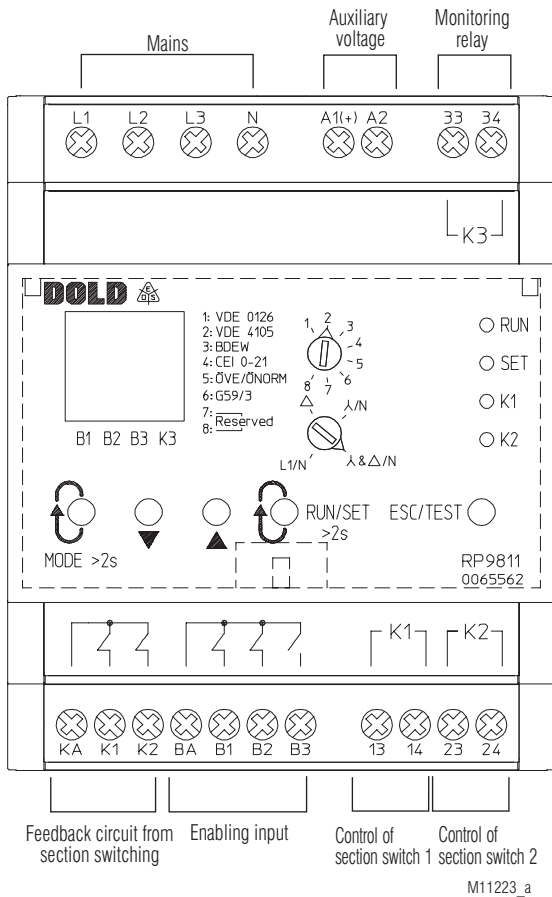

M11223_a

The colour of the backlight indicates the operating status of the device

- Off:** No supply voltage connected
- Green:** Normal operation.
- Red:** Failure status.
- Yellow:** Warning (failure message not acknowledged or test button pressed).

Four display modes can be selected: the measured value display, operating data display, error memory display and the display of the set parameters. Switching between the display modes is done by pressing the "Mode" button long (> 2 s). Switching to the display of the parameters set is done by pressing the RUN/SET button long (> 2 s). When in the display mode of the parameters set, switch to the input mode for parameters to change the settings. This is done by pressing the ▼▲ button

Actual value display

Displays the actual frequency and the voltage. Short activation of the button "mode" displays the next value



Indicators

Display of the operating data

If the operating voltage is present, various operating data, e.g. the operating duration of the device or the disconnect time, is recorded and added.

Within this display mode the following operating data can be selected by short actuation of the "Mode" button:

- Od.1: „T.Run“: Σ Operating time (powersupply connected)
- Od.2: „t.Err“: Σ Alarm-/ Failure duration
- Od.3: „t.Xof“: Σ Duration of external disconnection (via input B1/B2/B3)

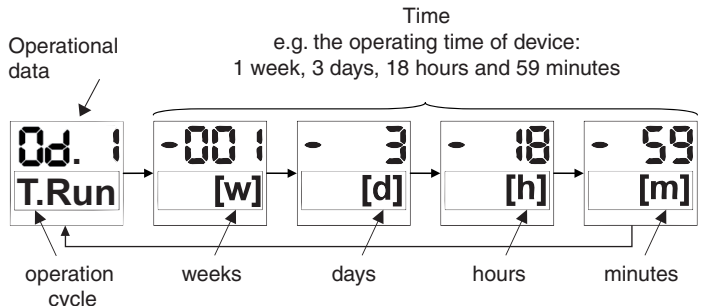

All operational data is deleted by pressing "Mode" and "Test" for more than 2 seconds in operational data display mode. The reset is confirmed on the display "ResOd" (Reset operational data).

Display of failure memory

In failure display mode the failure entries with failure cause and relative time to event are shown. Short activation of the button "mode" displays the next failure message. If no entries are stored, the display shows "NoErr".

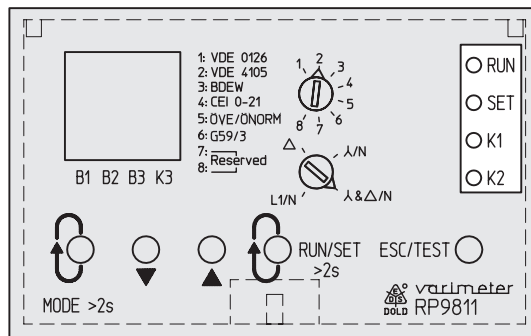
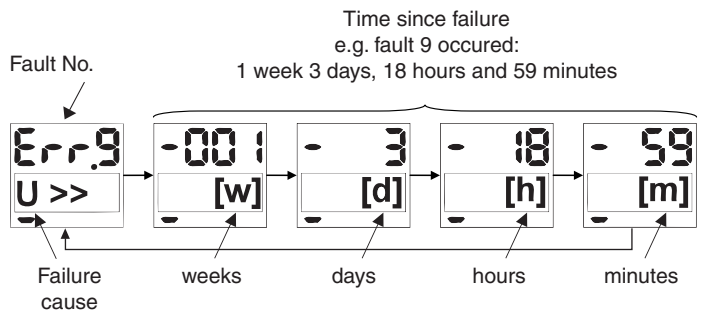

Indication LED

- RUN: Unit in RUN-Mode
- SET: Unit in Input-Mode

RUN+SET
simultaneity on: Adjusted parameters are displayed

K1 on: Section switch K1 energized
K1 flashing: Connecting delay is running

K2 on: Section switch K2 energized
K2 flashing: Connecting delay is running

Adjustment Facilities

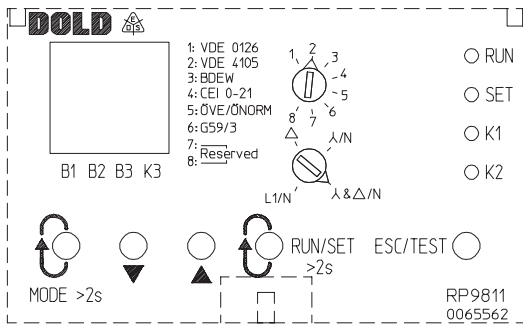

Operating element

MODE	Press the button > 2 s: Device switches to the display mode (measured value, operating data, error memory)
RUN/SET > 2 s:	Device switches to the parameter mode or also back to the display mode. In the parameter mode: Scroll through the parameters stored by briefly pressing the button. They are shown on the display. Press the button in the input mode > 2 s: Save parameters, switch to the RUN mode.
▲ Up	If the device is in the parameter mode, pressing these buttons switches to the input (SET) mode of the parameters.
▼ Down	The values are changed in the input mode.
ESC/TEST	Switch to the display mode without saving changed values. The device switches to the display (RUN) mode without saving the changed values. In the RUN and parameter mode: Test function is triggered; the disconnect time of the section switches is measured here and shown on the display in (ms).

Adjustment by rotational switch

Rotary switch Standard selection:

Device works according to

- 1: DIN VDE 0126-1-1:2013-08
- 2: VDE-AR-N 4105:2011-08
(rotary switch network connection: λ & Δ / N !)
- 3: BDEW-directive:2008-06
- 4: CEI 0-21:2012-06
- 5: ÖVE/ÖNORM E8001-4-712:2009
- 6: G59/3
- 7 ... 8: Reserved

Rotary switch network connection:

- △: Delta voltage
λ/N: Star voltage
λ & Δ/N: Delta- and star-voltage
L1/N: Voltage L1-N

Example:

Standard factory settings according to VDE-AR-N 4105:2011-08

(not for time delay for activation):

- Response value for: - Overfrequency $f > = 51.5$ Hz
Response value for: - Underfrequency $f < = 47.5$ Hz
Response value for: - Overvoltage $V >> = 115$ % of U_N
Response value for: - Undervoltage $V < = 80$ % of U_N
Response value for: - Overvoltage, 10 min mean value $V_{10m} > = 110$ %
Time delay for: - Reactivation $t_{on} = 60$ s

Adjustment Facilities

Remark to standard G59/3 (rotary switch for standard selection position 6)
The parameters for G59/3 LV (Low Voltage Grid) are preset.

If the RP9811 should operate according to G59/3 HV (High Voltage Grid) the following settings have to be changed:

e.g. for 110 V L-L: (rotary switch for standard selection position 6)

- Rotary switch network connection: Delta voltage
- Parameter Nr. 1: Nominal voltage (Phase to Phase) change from 400 V to 110 V.
- Parameter Nr. 2: $U >$ change from 114 % to 110 % (acc. to standard)
- Parameter Nr. 6: $U >>$ change from 119 % to 113 % (acc. to standard)
- Parameter Nr. 20: $U >$ On change from 114 % to 110 %

No.	Parameter	DIN VDE 0126-1-1:2013-08		VDE-AR-N 4105:2011-08		BDEW-medium voltage: 2008-06		Italy CEI 0-21:2012-06		ÖVE/ÖNORM E8001-4-712:2009		Großbritannien G59/3 Low Voltage Grid	
		Default	Setting range	Default	Setting range	Default	Setting range	Default	Setting range	Default	Setting range	Default	Setting range
Monitoring-/ disconnection parameters:													
1	Nominal voltage U_N (Delta- or star-voltage depending on rotary switch setting)	230V (400V)	50-230V (87-400V) Step 1V	230V (400V)	50-230V (87-400V) Step 1V	230V (400V)	50-230V (87-400V) Step 1V	230V (400V)	50-230V (87-400V) Step 1V	230V (400V)	50-230V (87-400V) Step 1V	230V (400V)	50-230V (87-400V) Step 1V
2	Overvoltage $U >$	off	100-130% / off Step 1%	off	100-130% / off Step 1%	108%	100-130% / off Step 1%	off	100-130% / off Step 1%	off	100-130% / off Step 1%	114%	100-130% / off Step 1%
3	Time delay overvoltage $t U >$	off	0-60s / off Step 0,1s	off	0-60s / off Step 0,1s	60s	0-60s / off Step 0,1s	off	0-60s / off Step 0,1s	off	0-60s / off Step 0,1s	1s	0-60s / off Step 0,1s
4	Overvoltage, 10 min mean value $U >$	110%	100-120% / off Step 1%	110%	100-120% / off Step 1%	off	100-120% / off Step 1%	110%	100-120% / off Step 1%	112%	110-115% / off Step 1%	off	100-120% / off Step 1%
5	time delay Overvoltage, 10 min mean value $t U >$	3s	0,2-10s / off Step 0,1s	3s	0,2-10s / off Step 0,1s	off	0,2-10s / off Step 0,1s	3s	0,05-10s / off Step 0,05s	off	0,2-10s / off Step 0,1s	off	0,2-10s / off Step 0,1s
6	Overvoltage 2 $U >>$	115%	100-130% Step 1%	115%	100-130% Step 1%	120%	100-130% Step 1%	115%	100-130% Step 1%	115%	100-130% Step 1%	119%	100-130% Step 1%
7	Time delay overvoltage 2 $t U >>$	off	0,05-10s / off Step 0,05s	off	0,05-10s / off Step 0,05s	off	0,05-10s / off Step 0,05s	0,2s	0,05-10s / off Step 0,05s	off	0,05-10s / off Step 0,05s	0,5s	0,05-10s / off Step 0,05s
8	Undervoltage $U <$	80%	10-100% Step 1%	80%	10-100% Step 1%	80%	10-100% Step 1%	85%	20-100% Step 1%	80%	10-100% Step 1%	87%	10-100% Step 1%
9	Time delay undervoltage $t U <$	off	0,05-10s / off Step 0,05s	off	0,05-10s / off Step 0,05s	2,7s	0,05-10s / off Step 0,05s	0,4s	0,05-10s / off Step 0,05s	off	0,05-10s / off Step 0,05s	2,5s	0,05-10s / off Step 0,05s
10	Undervoltage 2 $U <<$	off	10-100% / off Step 1%	off	10-100% / off Step 1%	45%	10-100% / off Step 1%	40%	20-100% / off Step 1%	off	10-100% / off Step 1%	80%	10-100% / off Step 1%
11	Time delay undervoltage 2 $t U <<$	off	0,05-10s / off Step 0,05s	off	0,05-10s / off Step 0,05s	0,3s	0,05-10s / off Step 0,05s	0,2s	0,05-10s / off Step 0,05s	off	0,05-10s / off Step 0,05s	0,5s	0,05-10s / off Step 0,05s
12	Overfrequency $f >$	50,2 Hz	50-52Hz / off Step 0,05Hz Random 50,2...51,5Hz	51,5 Hz	50-52Hz / off Step 0,05Hz Random 50,2...51,5Hz	51,5 Hz	50-52Hz / off Step 0,05Hz Random 50,2...51,5Hz	50,5 Hz	50-52Hz Step 0,05Hz Random 50,2...51,5Hz	51,0	50-52Hz Step 0,05Hz	51,5Hz	50-52Hz / off Step 0,05Hz
13	Time delay overfrequency $t f >$	off	0,05-10s / off Step 0,05s	off	0,05-10s / off Step 0,05s	off	0,05-10s / off Step 0,05s	0,1s	0,05-10s / off Step 0,05s	off	0,05-10s / off Step 0,05s	90s	0-99s / off Step 0,1s
14	Overfrequency 2 $f >>$	off	50-52Hz / off Step 0,05Hz	off	50-52Hz / off Step 0,05Hz	off	50-52Hz / off Step 0,05Hz	51,5 Hz	50-52Hz Step 0,05Hz	off	50-52Hz / off Step 0,05Hz	52,0Hz	50-52Hz / off Step 0,05Hz
15	Time delay overfrequency 2 $t f >>$	off	0,05-10s / off Step 0,05s	off	0,05-10s / off Step 0,05s	off	0,05-10s / off Step 0,05s	0,1s	0,05-10s / off Step 0,05s	off	0,05-10s / off Step 0,05s	0,5s	0,05-10s / off Step 0,05s
16	Underfrequency $f <$	47,5 Hz	47-50Hz Step 0,05Hz	47,5 Hz	47-50Hz Step 0,05Hz	47,5 Hz	47-50Hz Step 0,05Hz	49,5 Hz	47-50Hz Step 0,05Hz	47,0Hz	47-50Hz Step 0,05Hz	47,5Hz	47-50Hz Step 0,05Hz
17	Time delay underfrequency $t f <$	off	0,05-10s / off Step 0,05s	off	0,05-10s / off Step 0,05s	off	0,05-10s / off Step 0,05s	0,1s	0,05-10s / off Step 0,05s	off	0,05-10s / off Step 0,05s	20s	0-99s / off Step 0,1s
18	Underfrequency 2 $f <<$	off	47-50Hz / off Step 0,05Hz	off	47-50Hz / off Step 0,05Hz	off	47-50Hz / off Step 0,05Hz	47,5 Hz	47-50Hz Step 0,05Hz	off	47-50Hz / off Step 0,05Hz	47,0Hz	47-50Hz / off Step 0,05Hz
19	Time delay underfrequency 2 $t f <<$	off	0,05-10s / off Step 0,05s	off	0,05-10s / off Step 0,05s	off	0,05-10s / off Step 0,05s	0,1s	0,05-10s / off Step 0,05s	off	0,05-10s / off Step 0,05s	0,5s	0,05-10s / off Step 0,05s

No.	Parameter	DIN VDE 0126-1-1:2013-08		VDE-AR-N 4105:2011-08		BDEW-medium voltage: 2008-06		Italy CEI 0-21:2012-06		ÖVEÖNORM E8001-4-712:2009		Großbritannien G59/3 Low Voltage Grid	
		Default	Setting range	Default	Setting range	Default	Setting range	Default	Setting range	Default	Setting range	Default	Setting range
Connection parameters:													
20	Reactivation after overvoltage U _{>} On	110%	100-120% / off Step 1%	110%	100-120% / off Step 1%	off	100-120% / off Step 1%	110%	100-120% / off Step 1%	112%	100-120% / off Step 1%	114%	100-120% / off Step 1%
21	Reactivation after undervoltage U _{<} On	85%	20-100% Step 1%	85%	20-100% Step 1%	95%	20-100% Step 1%	85%	20-100% Step 1%	80%	20-100% Step 1%	87%	20-100% Step 1%
22	Reactivation after overfrequency f _{>} On	50,05 Hz	50-52Hz Step 0,05Hz	50,05 Hz	50-52Hz Step 0,05Hz	50,05 Hz	50-52Hz Step 0,05Hz	50,10 Hz	50-52Hz Step 0,05Hz	51,0Hz	50-52Hz Step 0,05Hz	51,5Hz	50-52Hz Step 0,05Hz
23	Reactivation after underfrequency f _{<} On	47,5 Hz	47-50Hz Step 0,05Hz	47,5 Hz	47-50Hz Step 0,05Hz	47,5 Hz	47-50Hz Step 0,05Hz	49,9 Hz	47-50Hz Step 0,05Hz	47,0Hz	47-50Hz Step 0,05Hz	47,5Hz	47-50Hz Step 0,05Hz
24	Time delay for reactivation t _{On}	60s	1-600s Step 1s Random 60...600s	60s	1-600s Step 1s Random 60...600s	1s	1-600s Step 1s Random 60...600s	300s	1-600s Step 1s Random 60...600s	30s	1-600s Step 1s	20s	1-600s Step 1s
25	Short time interruption t _{OnSh}	off	on / off	on	on / off	off	on / off	off	on / off	on	on / off	on	on / off
RoCoF/Vector shift:													
26	Rate of Change of Frequency RoCoF	off	0,10-5Hz/s / off Step 0,01Hz/s	off	0,10-5Hz/s / off Step 0,01Hz/s	off	0,10-5Hz/s / off Step 0,01Hz/s	off	0,10-5Hz/s / off Step 0,01Hz/s	off	0,10-5Hz/s / off Step 0,01Hz/s	off	0,10-5Hz/s / off Step 0,01Hz/s
27	Time delay t _{RCF}	off	0,05-10s / off Step 0,05s	off	0,05-10s / off Step 0,05s	off	0,05-10s / off Step 0,05s	off	0,05-10s / off Step 0,05s	off	0,05-10s / off Step 0,05s	off	0,05-10s / off Step 0,05s
28	Number of periods Perio	10	4-50 Step 1	10	4-50 Step 1	10	4-50 Step 1	10	4-50 Step 1	10	4-50 Step 1	10	4-50 Step 1
29	Vector shift VecSh	off	2-20° / off Step 1°	off	2-20° / off Step 1°	off	2-20° / off Step 1°	off	2-20° / off Step 1°	off	2-20° / off Step 1°	off	2-20° / off Step 1°
30	Number of phases Phase	1	1 / 3	1	1 / 3	1	1 / 3	1	1 / 3	1	1 / 3	1	1 / 3
General parameters:													
31	Monitoring delay section switches tv _{KS}	0,25s	0,05-10s Step 0,05s	0,25s	0,05-10s Step 0,05s	0,25s	0,05-10s Step 0,05s	0,25s	0,05-10s Step 0,05s	0,25s	0,05-10s Step 0,05s	0,25s	0,05-10s Step 0,05s
32	Mode (only at CEI 0-21:2012-06 Italy)	---	---	---	---	---	---	Mode0	Mode0: Transitori Mode1: Definit	---	---	---	---
33	Switching mode of output relays	RL no	RL no: normal-ly open	RL no	RL no: normal-ly open	RL no	RL no: normal-ly open	RL no	RL no: normal-ly open	RL no	RL no: normal-ly open	RL no	RL no: normal-ly open
34	Number of section switch (only at CEI0-21 Italy)	KS 2	KS 0: ¹⁾ KS 1: ²⁾ KS 2: ³⁾ Sync: ⁴⁾	KS 2	KS 0: ¹⁾ KS 1: ²⁾ KS 2: ³⁾ Sync: ⁴⁾	KS 2	KS 0: ¹⁾ KS 1: ²⁾ KS 2: ³⁾ Sync: ⁴⁾	KS 2	KS 0: ¹⁾ KS 1: ²⁾ KS 2: ³⁾ Sync: ⁴⁾	KS 2	KS 0: ¹⁾ KS 1: ²⁾ KS 2: ³⁾ Sync: ⁴⁾	KS 2	KS 0: ¹⁾ KS 1: ²⁾ KS 2: ³⁾ Sync: ⁴⁾
35	Password Pwd	0000	0000-9999 Step 1	0000	0000-9999 Step 1	0000	0000-9999 Step 1	0000	0000-9999 Step 1	0000	0000-9999 Step 1	0000	0000-9999 Step 1

¹⁾ KS 0: No section switch
²⁾ KS 1: 1 section switch
³⁾ KS 2: 2 section switches
⁴⁾ Sync: Mains synchronization
Comment on parameter no. 31:
 The scan delay of the section switches (tv_{KS}) must be greater than the actual time of the section switches. The adjustable delay is active when the section switches close. (Motor driven sector switches have longer connection times). The monitoring delay when disconnecting is fixed at 250 ms.

Running chart parametrization

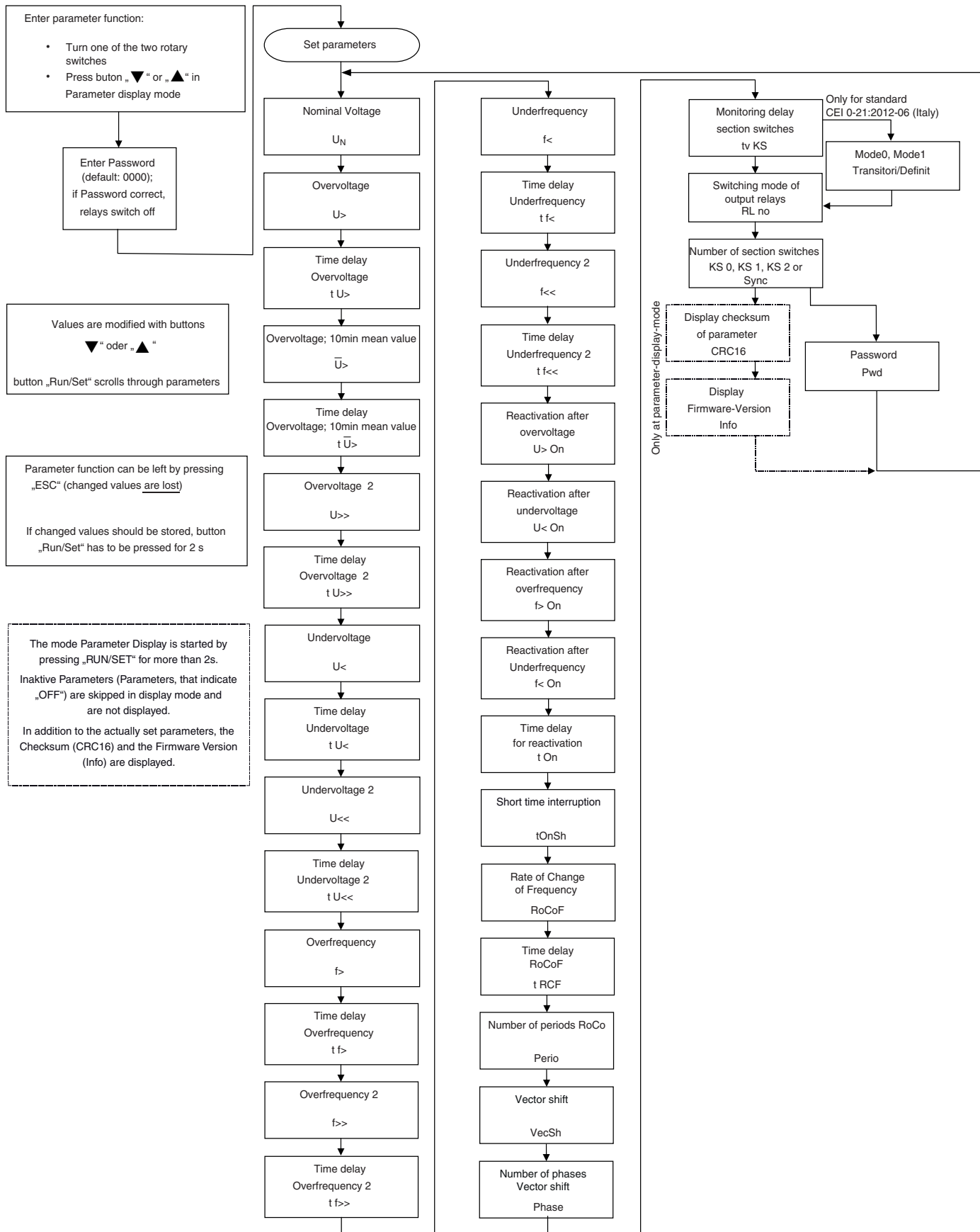

CRC16-value (Test value of parameter setting)

Below, the CRC16 values for the different positions of the two rotary switches are listed for standard and system configuration. The CRC16 values listed are obtained from the standard set, the system configuration and the associated default values of the parameter setting. If different parameters are selected than the default settings, different CRC16 values are obtained. They are not listed here.

Standard	Mains form	CRC16- value *)
DIN VDE 0126-1-1:2013-08	Y & Δ / N	ddcA
DIN VDE 0126-1-1:2013-08	Y / N	d85F
VDE-AR-N 4105:2011-08	Y & Δ / N	3b56
BDEW-directive:2008-06	Y & Δ / N	18b5
BDEW-directive:2008-06	Y / N	1d20
BDEW-directive:2008-06	Δ	1E53
CEI 0-21:2012-06	Y & Δ / N	3bc4
CEI 0-21:2012-06	Y / N	3E51
ÖVE/ÖNORM E8001-4-712:2009	Y & Δ / N	cb04
G59/3 LV	Y & Δ / N	5dE8
G59/3 LV	Y / N	587d
G59/3 HV 110V	Δ	47d3

*) Firmware-Version ≥ 04.00

Set parameters

Input-Mode

Via rotary switch the default settings for 6 standards can be adjusted quickly:

- | | |
|--|--------------|
| 1: DIN VDE 0126-1-1:2013-08 | 1: VDE 0126 |
| 2: VDE-AR-N 4105:2011-08 | 2: VDE 4105 |
| 3: BDEW-directive:2008-06 medium voltage | 3: BDEW |
| 4: Italien CEI 0-21:2012-06 | 4: CEI 0-21 |
| 5: ÖVE/ÖNORM E8001-4-712:2009 | 5: ÖVE/ÖNORM |
| 6: G59/3 | 6: G59/3 |
| 7: Reserved | 7: Reserved |
| 8: Reserved | 8: Reserved |

The default settings can be selected via the rotary switch thereby accepting the default settings of the parameter table. The individual parameters can be changed manually if needed.

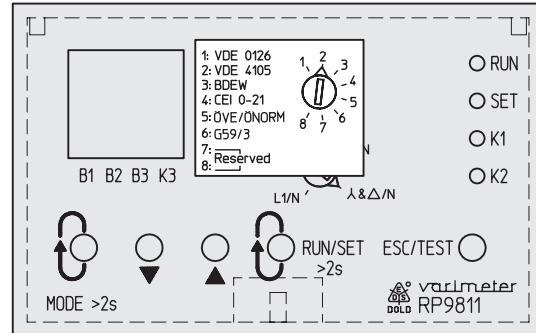

To change the parameters manually, the RUN/SET button must be pressed longer than two seconds. The display mode is accessed. The input mode is accessed when subsequently pressing "▼▲". The input mode is also accessed by turning one of the two rotary switches.

Before the values of a parameter can be modified, the password has to be entered correctly, or the default password (factory set) has to be acknowledged by pressing the RUN/SET button 4 times. The display then shows OK !

The password consists of four numbers from 0000-9999

Change of password:

To avoid unintended modifications the following sequence has to be followed:

1. Use RUN/SET button to select parameter no. 35 select "Password PWD"
2. Enter password with buttons ▼▲
3. Acknowledge password by pressing RUN/SET button, the display now shows "Pwd 2"
4. Repeat step 2. And 3. until display changes to parameter no. 1
5. Other parameter changes can be made. By pressing RUN/SET button for longer than 2 sec the changes are stored. The device changes to RUN mode display.

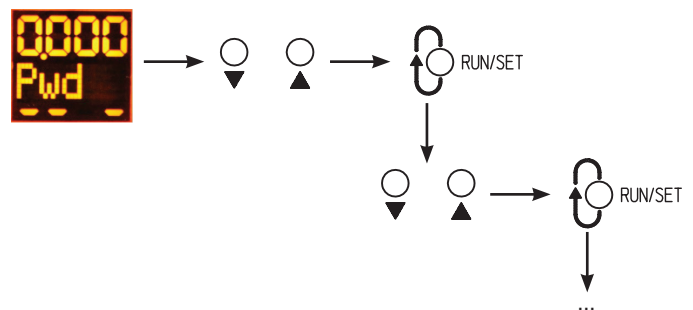

If the password is correct, the different parameters can be changed or parameters can be set to "active" or "inactive". Changing the different parameters is done analogue to the display mode by using the RUN/SET button.

Set parameters

Display mode

All parameters currently set to "active" are shown in the display mode. Scrolling between the different "active" parameters is possible with the RUN/SET button.

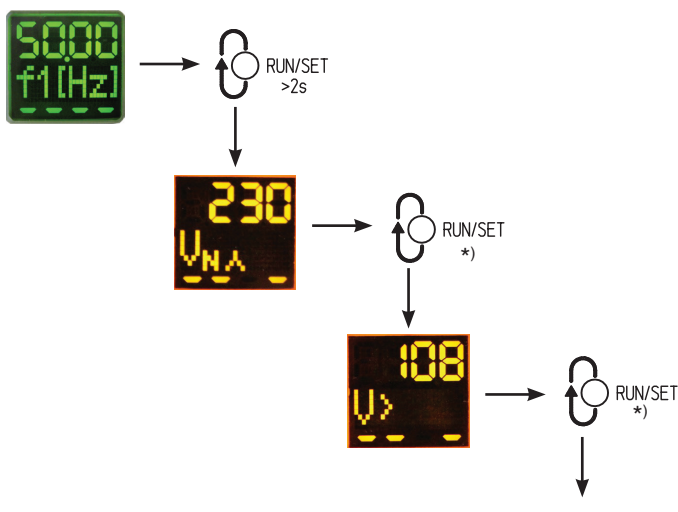
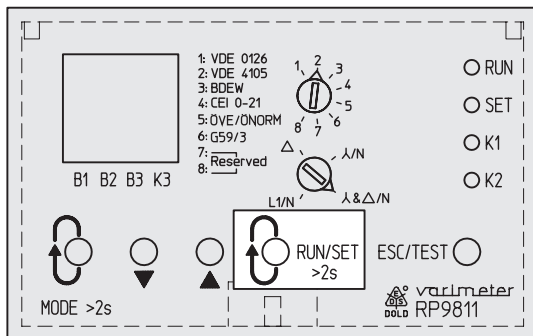

*) briefly pressing the button is sufficient for scrolling

Set parameters

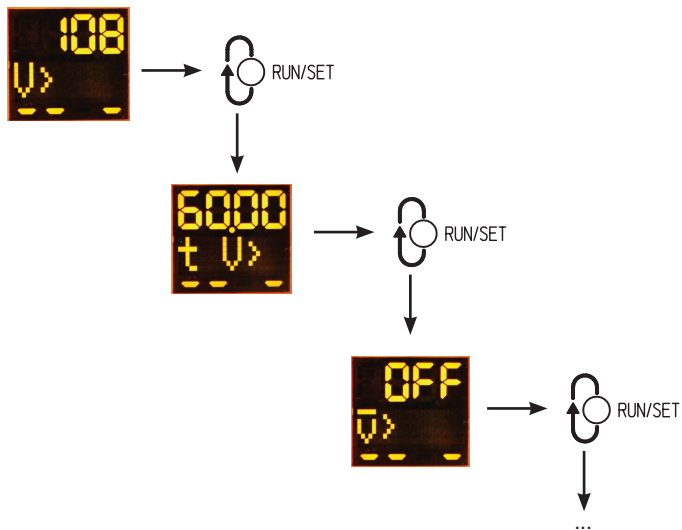

The default values set in the parameters (see parameter table) can be individually adjusted with the ▼▲ buttons; however, they must be within the respective setting ranges. The next parameter can be selected with the RUN/SET button and also be adjusted with the ▼▲ buttons.

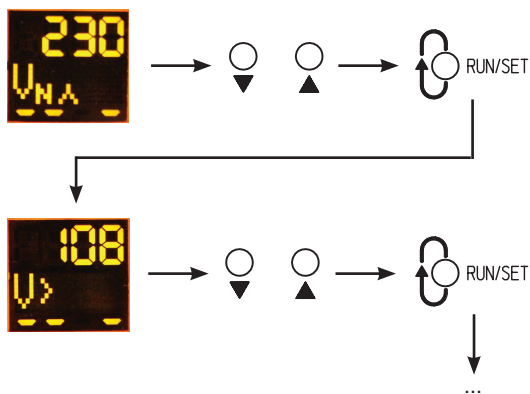

After the desired changes have been made, the new values are saved by pressing the RUN/SET button (> 2 s).

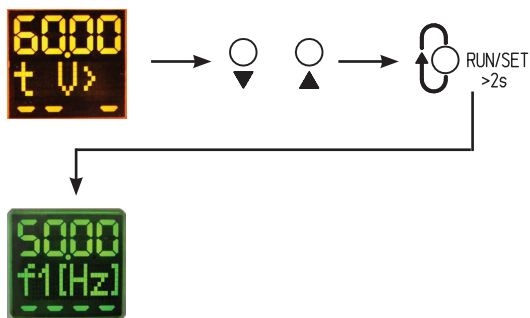

Set parameters

Jumping back to the display mode is possible at any time by pressing the ESC/TEST button without saving the changed parameters.

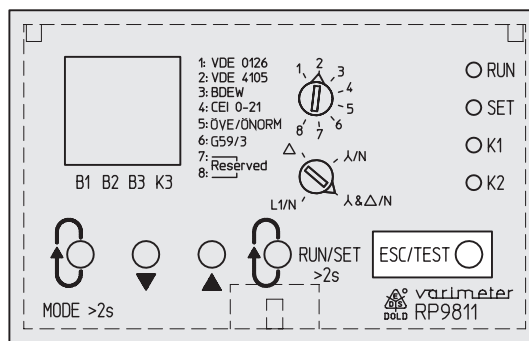

Wrong or contradictory entries of parameter values are recognised and displayed by the device as errors (setup errors). The error status can be exited by pressing the RUN/SET button longer than two seconds. The faulty parameters can be corrected back in the input mode.

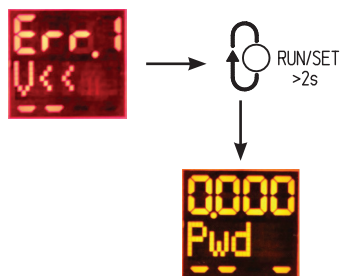

Error Indication

The failure status of the unit is indicated by a red backlight. If a failure is detected the unit automatically changes to failure memory display. The last 9 failures are stored, where failure 1 is the newest and failure 9 the oldest. The failures are displayed as follows

Failure indication; Failure cause		
Parameter Nr.	Display	Failure
2	V>	Overvoltage
4	\bar{V} >	Overvoltage, 10 min mean value
6	V>>	Overvoltage 2
8	V<	Undervoltage
10	V<<	Undervoltage 2
12	f1>	Overfrequency
14	f1>>	Overfrequency 2
16	f1<	Underfrequency
18	f1<<	Underfrequency 2
26	RoCoF	Frequency change df/dt (Rate of Change of Frequency)
29	VecSh	Vector shift detected (Vector Shift)
	KS1, KS2	Failure section switch (broken wire in feedback circuit or section switch contacts welded)
	Sys.5	Measured value deviation between channel 1 and channel 2 too large; locks the memory, cancelling the lock: Switch off auxiliary voltage longer than 60 s.
	Int.8	Failure during system test KS1 and KS2 have not been disconnected from grid
	Setup	The setting of the two potentiometers (standard and mains) is not correct, set values are not plausible (e.g. connection and disconnection value).

When leaving the failure state, the backlight changes from red to yellow in the first step. Only when the failures are acknowledged, either by deleting the failure memory or by changes to the actual value in the display mode, the backlight changes to green. The entries in the failure memory stay valid when resetting a failure message (pressing the pushbutton "Mode" for > 2 s).

The failure memory is deleted by pressing the buttons "Mode" and "Test" simultaneously for more than 2 seconds in display mode failure or by disconnecting the supply (A1 / A2) for min. 60 seconds. If a Sys.X or IntX fault cannot be reset by disconnecting the supply voltage for minimum 60 seconds, then then contact the manufacturer.

Fault Signalling Relay

A third output relay K3 indicates the disconnection of the generator system in the case of a failure (contact 33-34).

Isolated Grid Detection

The RP 9811 includes a passive procedure to detect an isolated network according to chapter 6.5.3 and annex D2 of VDE-AR-N 4105:2011-08 and chapter A.3.5.3 of ÖVE/ÖNORM E8001-4-712:2009. The 3-phase voltage monitoring allows an isolated network to be detected.

Random Switch Off at Overfrequency

In VDE-AR-N 4105:2011-08 a frequency range between 50.2 Hz and 51.5 Hz was defined. In this range a step less reduction of the generated power can be made if the generator is controllable.

Non controllable generator systems can alternatively disconnect themselves from the mains in the frequency range of 50.2 Hz and 51.5 Hz. In this case a symmetric distribution within this range of the disconnection frequency for each plant has to be observed. The RP 9811 has a random setting facility within this range, by turning both related switches into position "random". With this setting the connection and reconnection time is automatically selected within a range of 1 ... 10 minutes.

Random Controlled Connection T_{on}

The device offers the possibility to use a random control for connection with a delay between 60 and 600 s. Parameter T_{on} : "random"

System Test

When operating the pushbutton „Test“ the states of the section switch can be tested for correct function. Pressing the test button disconnects the generator system from the mains.

Evaluation of disconnection time:

When the test function is operated the release time of the section switch is monitored via the feedback circuit. The measured time is shown on the LCD display.

To determine the full disconnection time the measuring and evaluation time is added to the release time of the section switch.

Control inputs B1, B2, B3

Power up conditions (release)

The distributed power generation system is connected to the grid when the following conditions are met at the control inputs B1, B2, B3.

1. Inputs BA-B1 and BA-B2 are bridged
2. Input BA-B3 is open (operates inverted)
3. Both section switches are switched off. KA-K1 and KA-K2 are closed.

KA-K1 and KA-K2 are open after the connection.

If this is not the case, error KS1 or KS2 is indicated on the display.

If both section switches fail, KS1 and KS2 are entered in the error memory. The error message relay K3 releases in case of error.

Function control input B2 at adjustable standard CEI 0-21:2012-06

Mode Transitori (default):

BA-B2 closed  : Monitoring of tight frequency window [f>, f<]

BA-B2 open  : Monitoring of wide frequency window [f>>, f<<]

Mode Definit:

BA-B2 no function: Monitoring of wide frequency window [f>>, f<<]

Required parameter setting for Mode Definit:

Parameter No. 15 [t f>>]: 1 s
Parameter No. 19 [t f<<]: 4 s

Monitoring of Section Switches at mains synchronization

Via the 2 contacts 13-14 and 23-24 the 2 section switches are controlled. The monitoring of the section switches is made by the feedback circuit (terminals KA-K1, KA-K2), to which the NC contacts of the section switches are connected (see connection diagrams).

The voltage and frequency monitor RP 9811 only connects the generator system to the mains when in disconnected state the feedback circuits KA-K1, KA-K2 are closed, i.e. the section switches are de-energised (NC contacts are closed). As long as the section switch is not energized the feedback circuits KA-K1, KA-K2 must be closed if not the failure "KS" is displayed.

The feedback loops KA-K1, KA-K2 must be open after the section switch is selected, otherwise device 2 performs additional connection attempts. If the connection was not successful after the 3rd attempt, the error "KS" is reported and the error message relay switches to the normal position.

Parameter number of section switches = 0:

Only for simplifying the set-up procedure the monitoring of the feedback circuit can be disabled.

To fulfil the starting conditions, K1 and K2 has to be bridged with KA.

If only one section switch is installed, K1 and K2 are connected in parallel.

Function Mains synchronization on generator operation:

Parameter number of section switches = „Sync“

This function is available in units with firmware 02.00 and higher.

See relevant application example.

The monitoring of the Feedback contacts can be disabled with the enabling input BA/B3.

BA/B3 closed = feedback contact section switch 2 is disabled

BA/B3 open = both feedback contacts channel 1 and channel 2 are monitored.

Starting condition: BA/B1-B2-B3 bridged, or with standard CEI 0-21:2012-06 BA/B1-B3 bridged.

According to the Italian standard CEI 0-21:2012-06 (< 20 kW)

Using only one section switch is possible. This is permissible for systems < 20 kW.

Coupling switch K1 is connected to terminals 13/14. The feedback contacts terminal K1/K2 of the two section switches must be switched in parallel (bridge between terminal K1 and K2). Setting the number of section switches: Parameter [34] = KS 1 (1 section switch).

Even if only one section switch is connected, monitoring by the RP 9811.03 takes place via two channels.

Note:

If the feedback contacts terminal K1/K2 are bridged. LED K2 indicates the status of channel 2 and is on corresponding to LED K1 of channel 1. The connection condition is identical with systems > 20 kW.



Safety notes



Dangerous voltage.
Electric shock will result in death or serious injury.



Disconnect all power supplies before servicing equipment.

- Faults must only be removed when the relay is disconnected
- The user has to make sure that the device and corresponding components are installed and wired according to the local rules and law (TUEV, VDE, Health and safety).
- Settings must only be changed by trained staff taking into account the safety regulations. Installation work must only be done when power is disconnected.
- Observe proper grounding of all components

Set Up Procedure

The connection has to be made according to the connection examples.

Technical Data		
Reactivation:	See parameter table "Connection parameters"	
Disconnection:	See parameter table "Monitoring-/ disconnection parameters"	
Accuracy:		
Voltage measurement:	$\leq \pm 1\%$ ± 1 digit (at AC 230 V)	
Frequency measurement:	$\leq \pm 0.02\%$ ± 1 digit	
Reaction time (Disconnection):	< 100 ms	
Disconnection by vector shift:	< 50 ms	
Auxiliary Voltage		
Auxiliary Voltage	Voltage range	Frequency range
AC/DC 24 ... 80 V	AC 18 ... 100 V	45 ... 400 Hz; DC 48 % W ^{*)}
	DC 18 ... 130 V	W $\leq 5\%$
AC/DC 80 ... 230 V	AC 60 ... 276 V	45 ... 400 Hz; DC 48 % W ^{*)}
	DC 50 ... 300 V	W $\leq 5\%$
*) W = Permitted residual ripple of auxiliary supply		
Nominal consumption		
DC 24, 48 V:	1.5 W	
AC 230 V:	4.2 VA	
Output		
Relay K1 and K2:	1 NO contact each	
Relay K3:	1 NO contact	
	The 3 Output relays are de-energized on trip, after disconnection or failure	
Thermal current I_{th}:	5 A	
Switching capacity		
according to AC 15		
NO contact:	3 A / AC 230 V	IEC/EN 60947-5-1
NC contact:	1 A / AC 230 V	IEC/EN 60947-5-1
Electrical life		
to AC 15 at 1 A, AC 230 V		
NO contact:	3 x 10 ⁵ switch. cycles	IEC/EN 60947-5-1
Short circuit strength		
max. fuse rating:	6 A gG / gL	IEC/EN 60947-5-1
Mechanical life:		
	> 50 x 10 ⁶ switching cycles	
General Data		
Measuring voltage range:	AC 15 ... 300 V (Phase-N) AC 26 ... 520 V (Phase-Phase)	
Frequency range:	46 ... 54 Hz	
Enabling inputs		
BA / B1, B2, B3:	DC 12 V (Ground- and volt-free contact)	
Temperature range:		
Operation:	- 30 ... + 60 °C	
Storage:	- 40 ... + 70 °C	
Altitude:	Up to 4000 m	IEC 60664-1
Clearance and creepage distance		
Rated impulse voltage /		
Pollution degree:		
Auxiliary circuit / measuring circuit /		
contacts:	5 kV / 2	IEC 60664-1
13-14 / 23-24:	4 kV / 2	IEC 60664-1
(at altitude > 2.000 m the contacts		
13-14 / 23-24 must be connectet on the		
same phase!)		
The measuring circuit includes:	L1, L2, L3, N, KA, K1, K2, BA, B1, B2, B3	
EMC		
Electrostatic discharge (ESD):	8 kV (air)	IEC/EN 61000-4-2
HF irradiation:	10 V/m	IEC/EN 61000-4-3
Fast transients:	2 kV	IEC/EN 61000-4-4
Surge		
between		
wires for power supply:	2 kV	IEC/EN 61000-4-5
Between wire and ground:	4 kV	IEC/EN 61000-4-5
HF wire guided:	20 V	IEC/EN 61000-4-6
Interference suppression:	Limit value class B	EN 55011

Technical Data	
Degree of protection	
Housing:	IP 30 (not sealed) IEC/EN 60529 IP 40 (sealed with seal wire 50/30) IEC/EN 60529
	The unit must be disconnected from the power supply before the seal is applied
Terminals:	IP 20 IEC/EN 60529
Housing:	Thermoplastic with VO behaviour according to UL subject 94
Vibration resistance:	Amplitude 0.35 mm frequency 10 ... 55 Hz, IEC/EN 60068-2-6 30 / 060 / 04 IEC/EN 60068-1
Climate resistance:	
Terminal designation:	EN 50005
Wire connection	
Cross section:	Solid, stranded 0.5 ... 4 mm ²
Flexible with plastic sleeve:	0.5 ... 4 mm ²
Multi-wire connection:	0.5 ... 1.5 mm ² (2 wires with the same diameter)
Stripping length:	6.5 mm
Max. fixing torque:	0.5 Nm
Wire fixing:	Plus-minus terminal screws / M3 box terminals
Mounting:	DIN-rail
Weight:	215 g
Recommended fuse for measuring inputs:	gG / gL 6 A
Dimensions	
Width x height x depth:	70 x 90 x 71 mm

Standard Types	
RP 9811.03	3/N AC 400 / 230 V
Article number:	0065562
• Auxiliary voltage U _H : AC/DC 80 ... 230 V	
RP 9811.03	3/N AC 400 / 230 V
Article number:	0065698
• Auxiliary voltage U _H : AC/DC 24 ... 80 V	

Application Examples

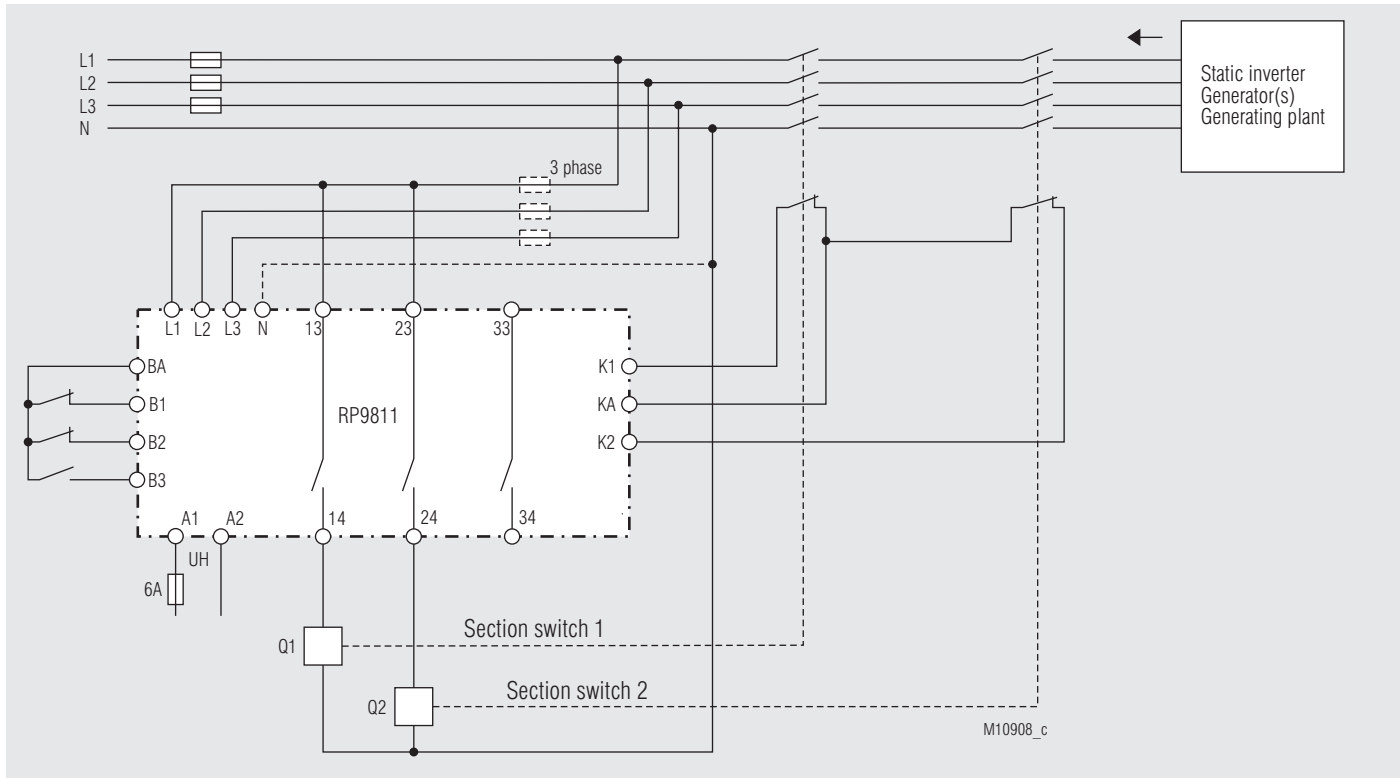

Application example according to DIN VDE-AR-N 4105:2011-08 (from 30 kW); CEI 0-21:2012-06 (from 20 kW); BDEW-directive:2008-06; DIN VDE 0126-1-1:2013-08
2 section switches

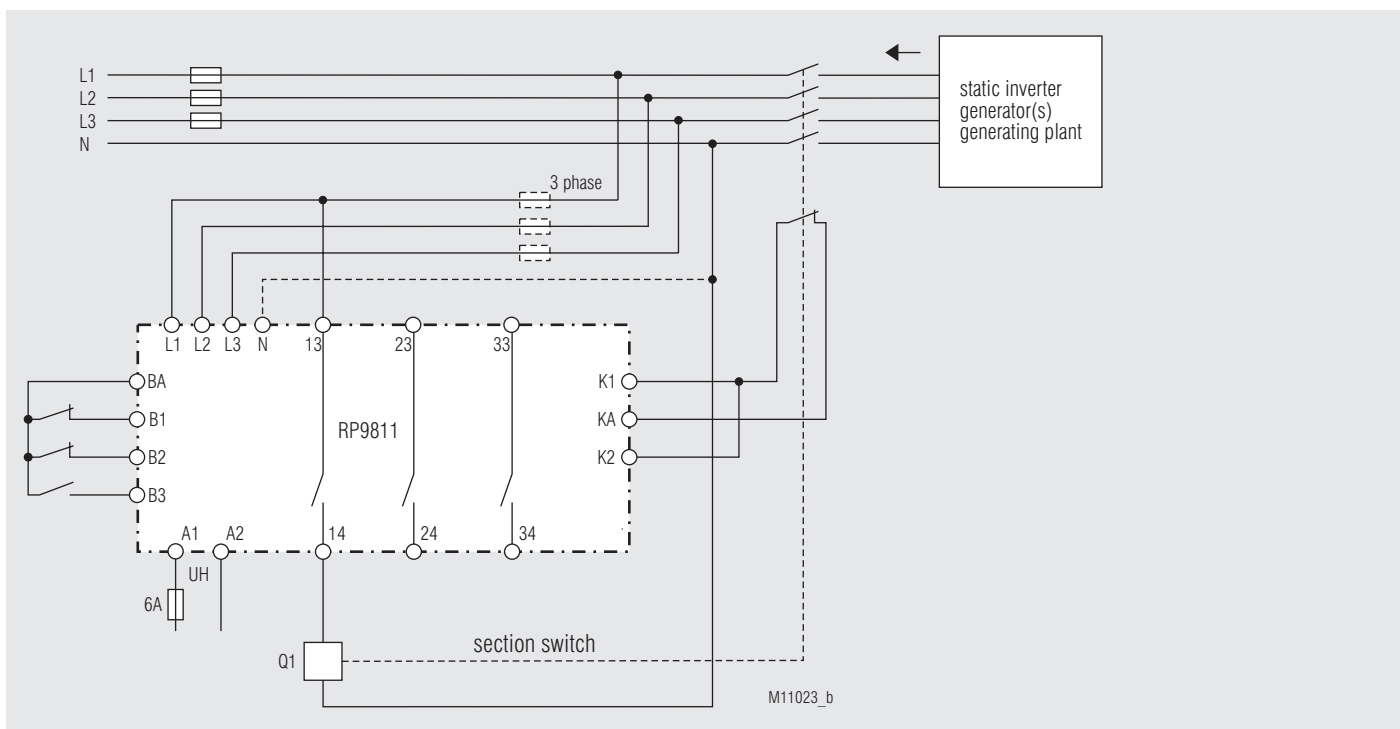

Application example according to CEI 0-21:2012-06 (< 20 kW)
1 section switch

