

VIDEO



+ Info



## SAFEMASTER STS

The key to  
more safety

Modular safety switches and key transfer systems  
for the highest requirements. **Now also  
available in a fibre reinforced polymer version!**

**DOLD**   
Our experience. Your safety.

# The ultimate safety system

## SAFEMASTER STS

### Revolutionary. Simple.

The SAFEMASTER STS safety switch and key transfer system serves to monitor the moveable safety guards found on machines and installations. It combines the advantages of safety switches, guard locks, key transfer and command functions in a single system. The rugged stainless steel or fibre reinforced polymer (FRP) interlocking system is suitable for many different uses, and can be individually tailored to your specific application.

### Modular. Flexible.

The building block system allows for flexible safety solutions adapted to the application – whether they are standalone solutions, complex system solutions, electrical, mechanical, or hybrid systems. The modular, expandable system reduces installation and maintenance work, since entrances and doors can be secured without any wiring.

### Safe. Tested.

SAFEMASTER STS is tested and approved according to legal requirements, and as an individual system is suitable for use in safety applications up to cat. 4 / PL e in accordance with EN ISO 13849-1.

### Economical. Sustainable.

With SAFEMASTER STS, your company can create customized wire free security concepts. This saves cost, power, effort and material. The components are long-lasting and recyclable. That makes this system a pioneer in terms of energy efficiency and environmental sustainability.

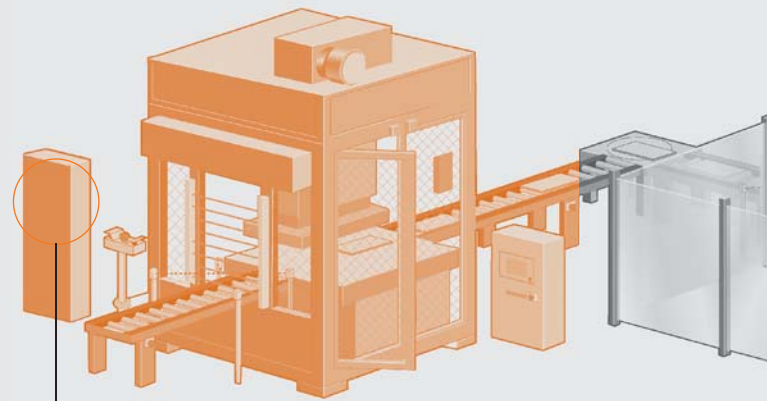

### Key transfer

#### Key operated switch

If, for instance, the machine is due for maintenance, it is switched off by withdrawing the key. This triggers a signal (idle state, safe state). The system then cannot be started as long as the key is missing.

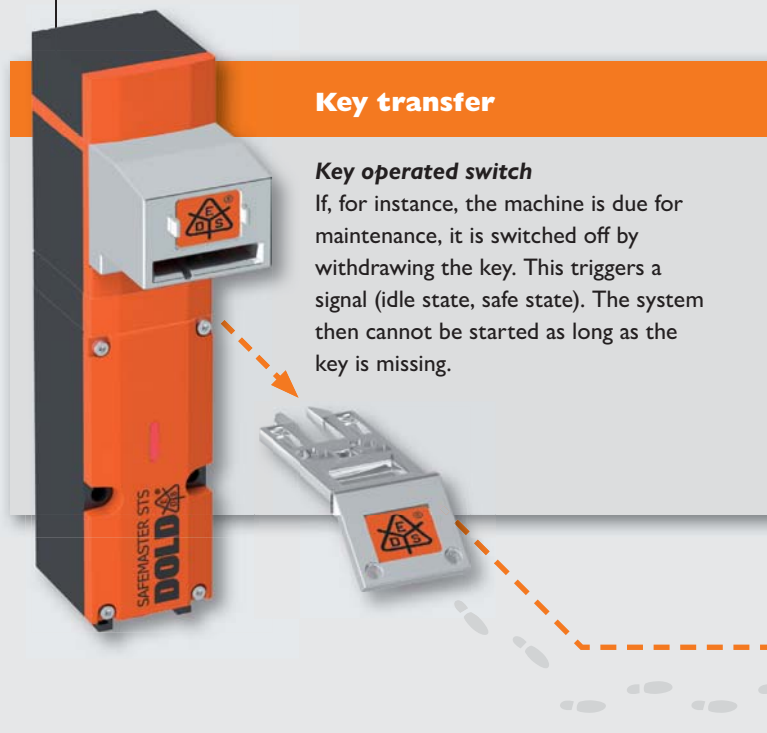

## Guard lock

### Solenoid guard lock

A solenoid controlled guard lock secures safety doors or entrances in a hazardous area during operation. Only when a release signal is present the guard lock is disengaged. The door can then be opened.

## Switch

### Safety switches

Safety switches are used for the electrical monitoring of access points or safety doors, for example. If an access point is opened whilst the system is operating, the system is immediately switched off.

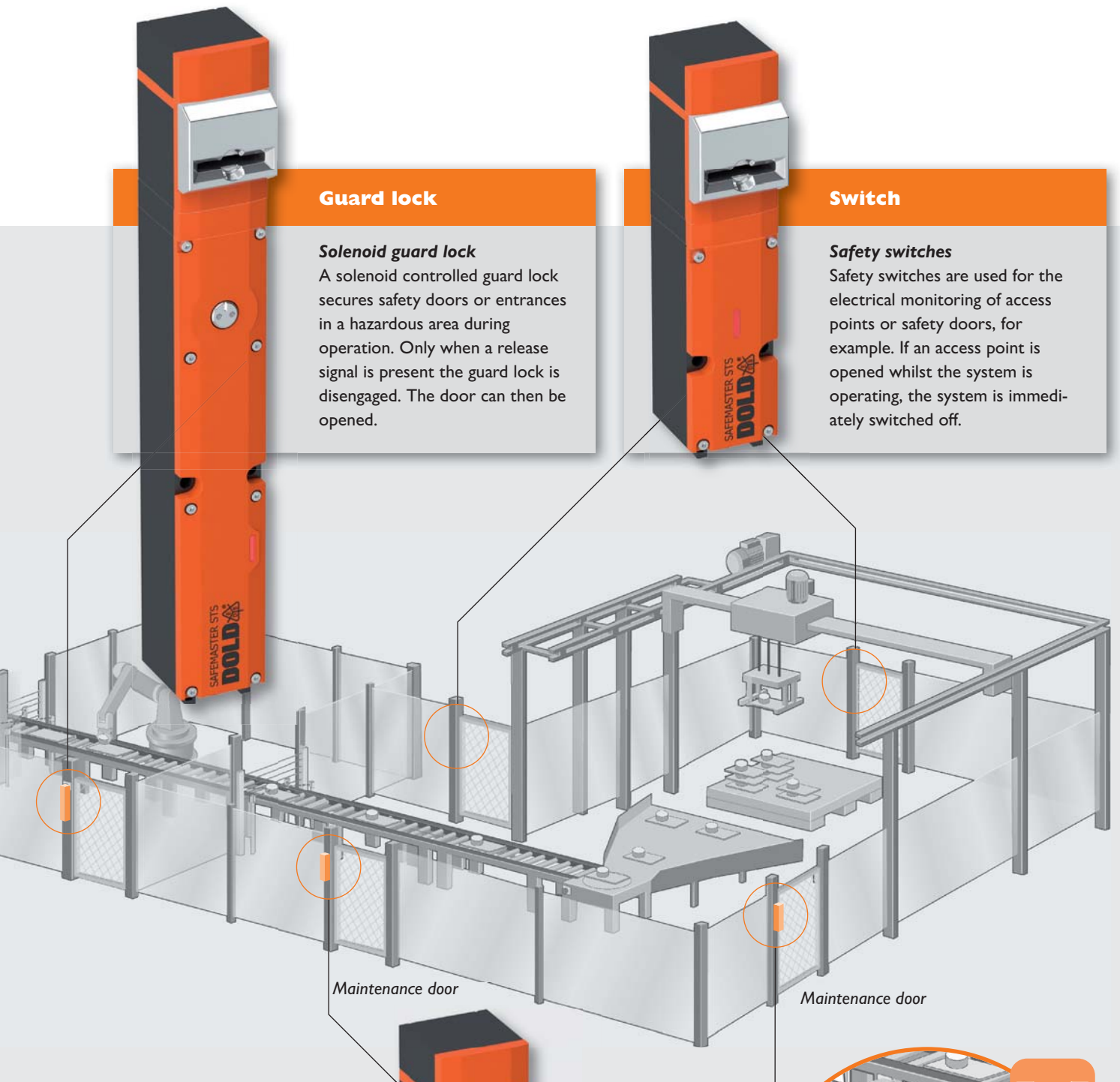

Maintenance door

Maintenance door

## Mechanical lock

After inserting the key from the key operated switch, the door can be opened without danger. So long as the door is open, the key remains locked and cannot be withdrawn. The mechanical lock enables access points to be secured without wiring.

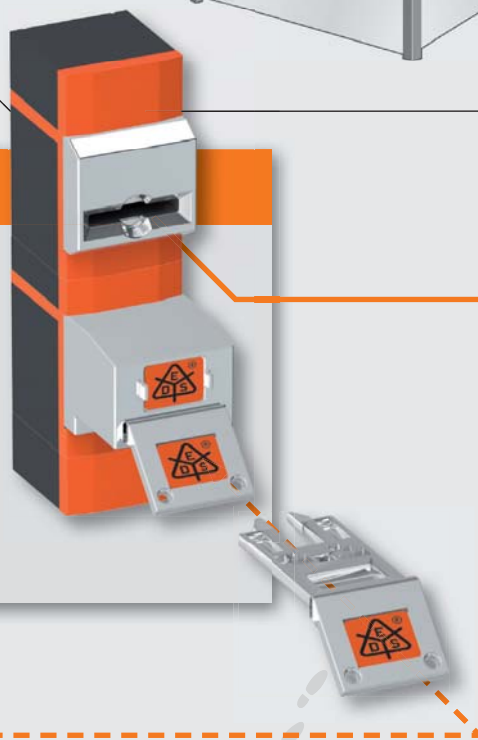

Key transfer

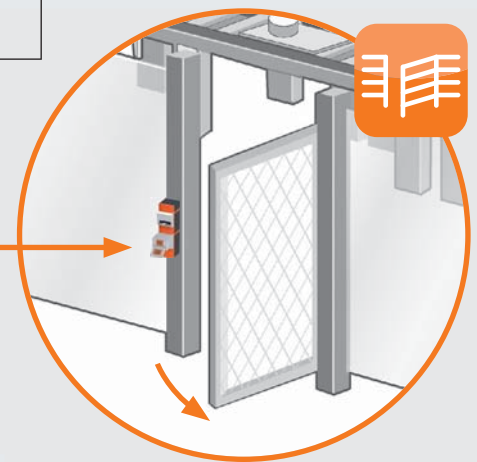

VIDEO



+ Info





# Reliable fibre reinforced polymer (FRP) version

## Fibre reinforced polymer (FRP) design

SAFEMASTER STS is the reliable safety switch and key transfer system used to secure safety guards protecting machines and systems. The system was designed according to the highest possible security standards and fulfills all relevant safety requirements. It reliably and securely protects both your employees and your machines and production systems. The FRP version stands out with its attractive design, strong visual effect, and simple handling. Its robust combination of stainless steel and FRP lends itself to a broad range of use, such as in automation technology, the automotive and railway industries.

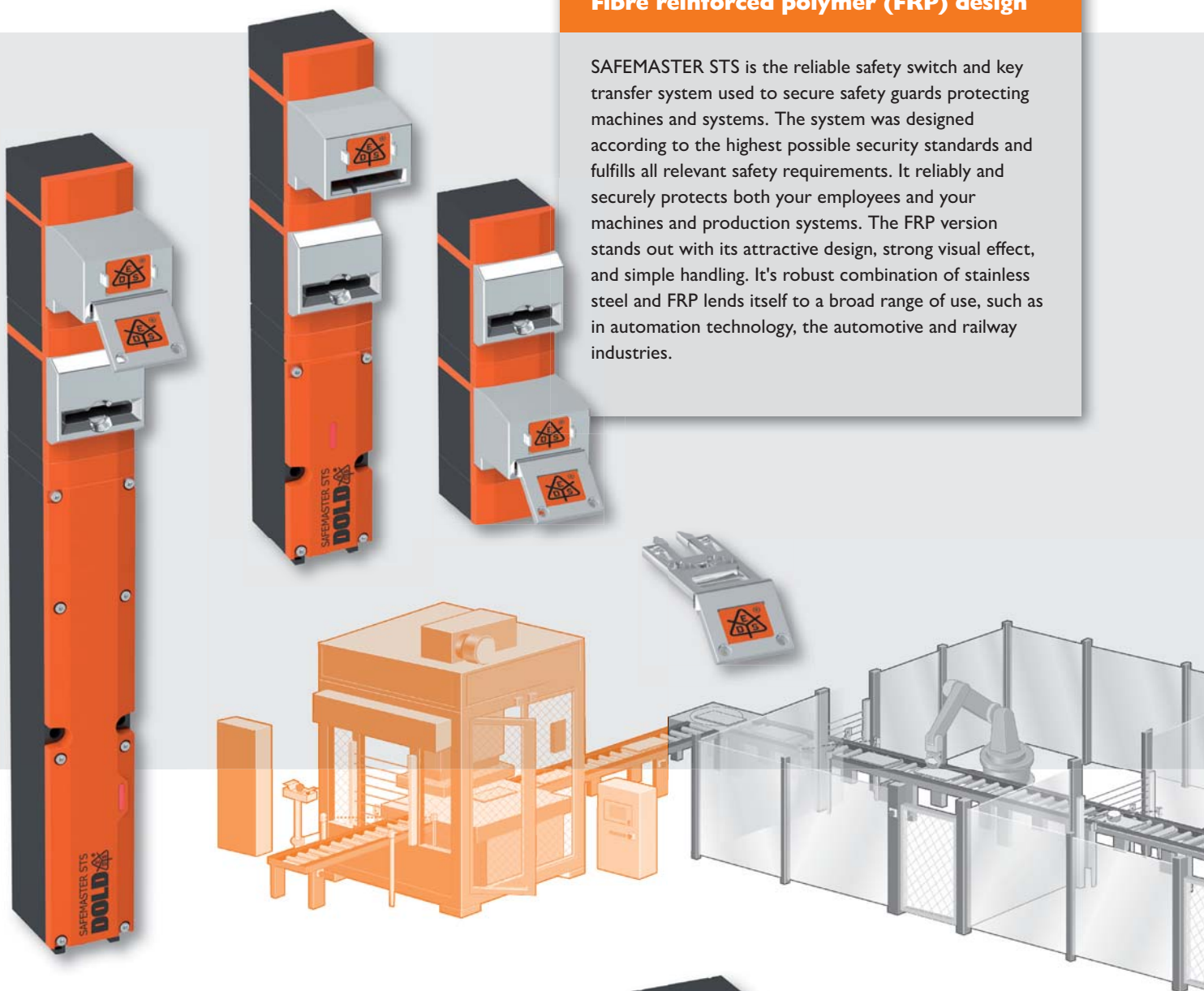

## Simple combination

SAFEMASTER STS also offers the option of a combination of fibre reinforced polymer and stainless steel design, for use in rugged environmental conditions. Thanks to its good cross compatibility, the system can be adapted to your specific application or task.



# Tough robust stainless steel version

## Stainless steel design

The robust and high-quality stainless steel design is well suited for use in rugged conditions, such as those in bulk goods handling areas in the chemical, food, or pharmaceutical industries. SAFEMASTER STS is also a practical solution for areas with extreme ambient temperature, moisture, and dirt.



For example, the FRP version can be used in your switch cabinet, and the stainless steel solution is well suited for extreme rough handling areas.



# Safety switches

## Safety switch (type 2)

SAFEMASTER STS series safety switches reliably secure access and protective doors and hatches, and are suitable for safety applications up to Cat. 4 / PL e in accordance with EN ISO 13849-1 without fault exclusion. They are suited for applications requiring a high level of security. The very narrow design also allows them to be installed on movable safety guards.

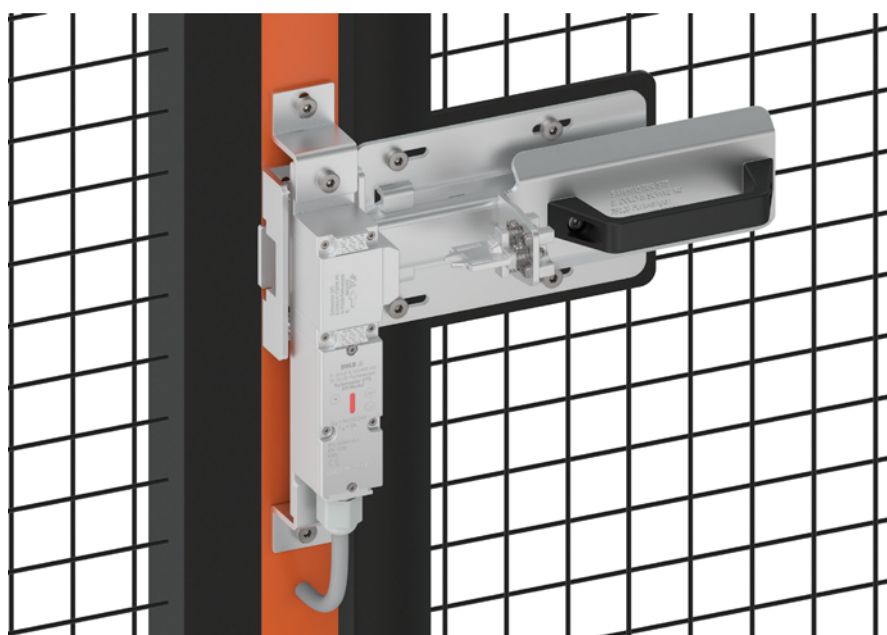
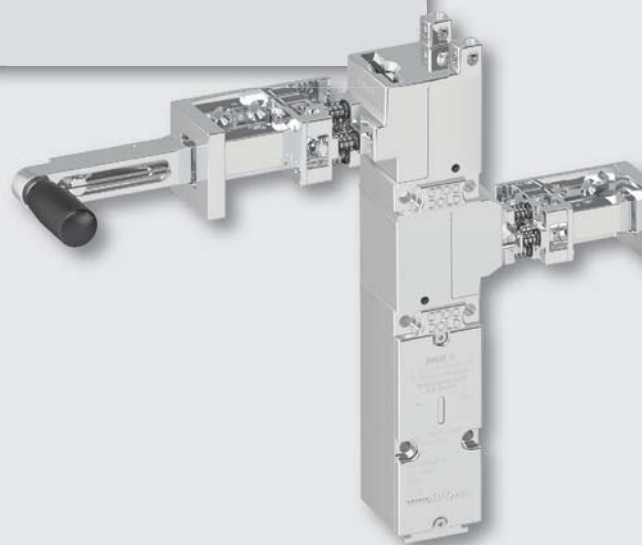

When the safety guards are opened, hazardous movements must immediately be switched off and secured against restart. The hazardous machinery can only be restarted once the safety guards are closed.

# Guard locks

## Mechanical / Solenoid guard lock

Guard locks in the SAFEMASTER STS family combine our trusted mechanical principle with the advantages of electromechanical safety switches with a 2-channel locking function. Thanks to their lock monitoring features, they can be used to reliably protect both processes and personnel. Different coding levels, very high locking forces, and comprehensive diagnostic capabilities allow them to be used in almost all safety-relevant applications.



An access door can only be opened after the machine controller has transmitted an enabling signal to the guard lock. As long as this enabling signal is active, the movable section of the safety guard can be opened and closed. If the release signal is cancelled, the safety guard is closed and the guard lock is reactivated. The machine can then be restarted. Possible uses include safety applications with machine or equipment follow-up movements involving high pressure or high temperatures.

# Key transfer – The principle

## Modular. Expandable. Flexible.

A trapped key safety switch (1) can contain multiple keys, thereby monitoring multiple access points at once without wiring (2, 3). A modular design allows the system to be expanded easily, for example with additional mechanical interlocking devices (4). This non wired safety aspect saves cost and increases the availability of the system.



## Wireless. Safe.

### Safety door closed and locked

To open the safety door, a key from the trapped key safety switch (1) must be inserted into the mechanical guard lock (2). Only then can the door be opened.

### Safety door opened, key retained

As long as the door is open, the key is retained in the mechanical guard lock (2). Only once the door is closed the key can be removed. The system-enforced process means that it is only possible to start the machine once all keys (2, 3 and 4) are re-inserted into the trapped key safety switch (1).



# Hybrid system – Ergonomic safeguard

## Reduced wiring. Ergonomic.

SAFEMASTER STS combines the advantages of safety switches, guard locks, key transfer and command functions in a single system. The hybrid system offers the advantage of an ergonomic operation for the whole system. For instance, a main entrance that is used frequently (1) can be monitored electrically, while access points used only rarely for maintenance and service (2, 3) can be secured by purely mechanical means, or without wiring using key transfer. The advantage of the hybrid solution in comparison to the classic key transfer solution is that the operator must travel shorter distances, and is able to operate the main entrance quickly. This saves time and increases productivity.

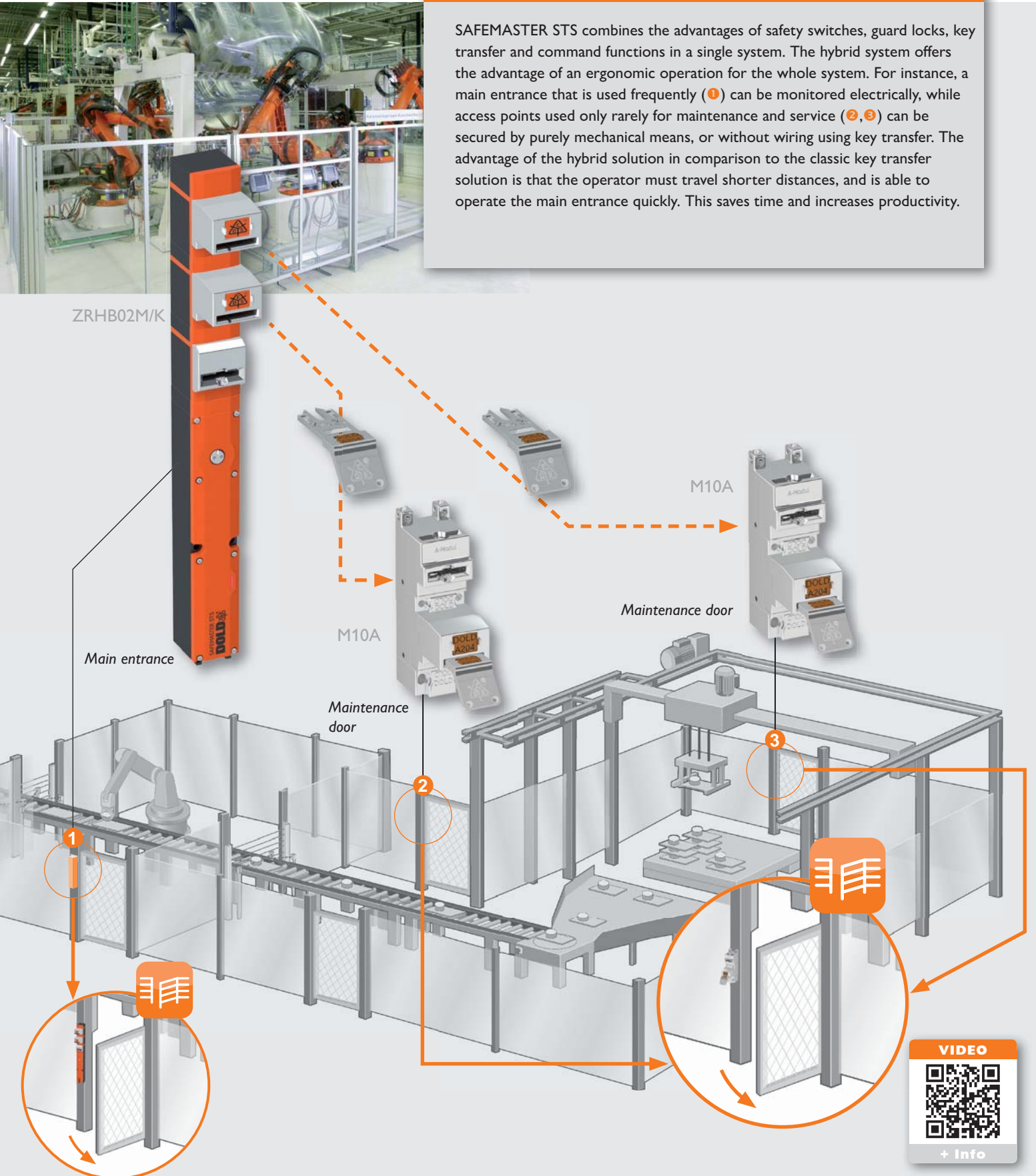

# Protection against being locked in - preventative measures



## Personal key

The employee must take the key with him into the facility for his own safety. By doing so, he safeguards himself against unexpected starting and protects himself from being locked in.



## Lock Out Tag Out (LOTO)

The padlock module offers an additional protective function. It enables LOTO functions to be integrated into the SAFEMASTER STS system. The key is pulled to the stop, and any worker who wishes to enter the facility inserts his personal padlock into the opening or gap designed for this purpose. Therefore, the mechanism can no longer be operated. The facility can only be restarted after all the padlocks have been removed and/or when all employees have left the facility.

## Prevention

## Authorised persons

Thanks to this module combination, an entrance can be safeguarded in an individual manner. Clearance is only granted when two different-coded keys are inserted. This ensures that an employee is only granted access with the knowledge of a second person.

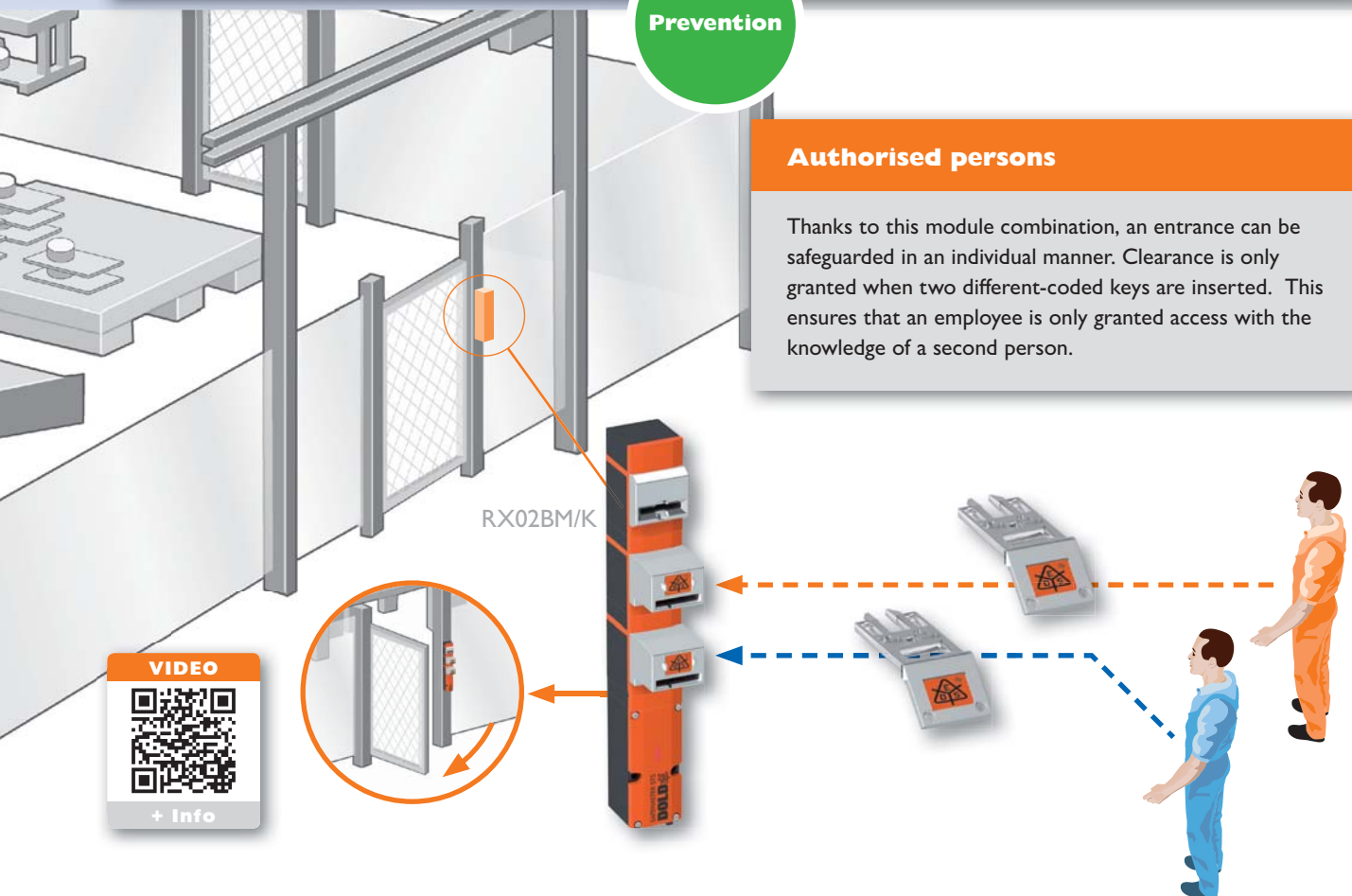

# Protection against being locked in - reliably control emergency situations

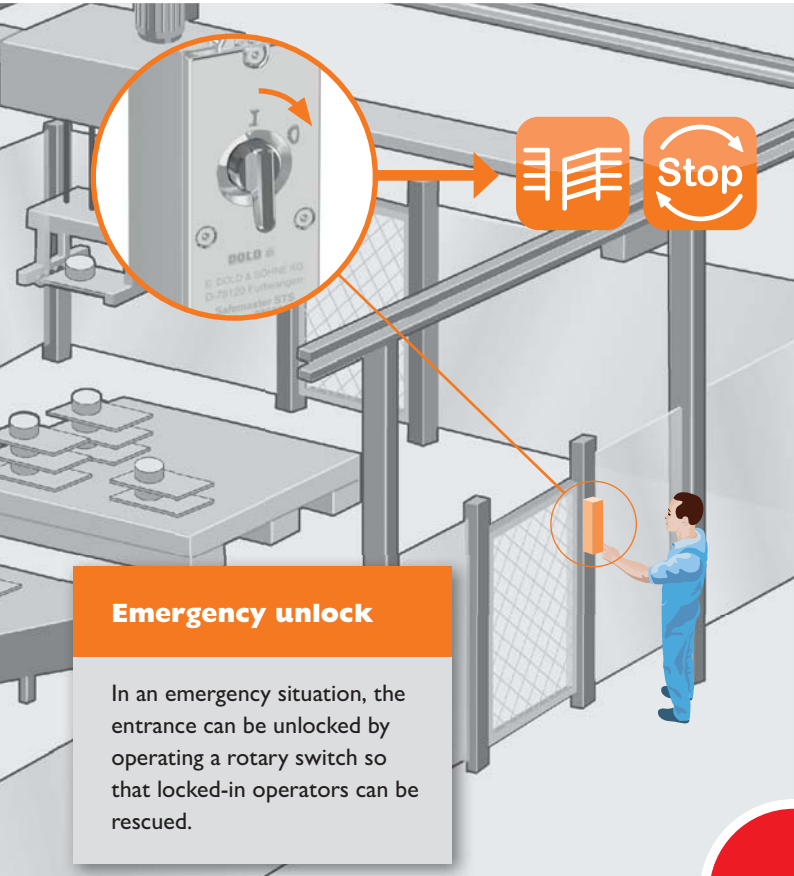

## Emergency unlock

In an emergency situation, the entrance can be unlocked by operating a rotary switch so that locked-in operators can be rescued.

## Escape and emergency release

SAFEMASTER STS also integrates escape releases and emergency unlocking. People who become locked in by accident can always safely leave the facility. Entrances can be equipped with an escape or emergency unlock mechanism. After it is triggered, locked-in operators can escape or be rescued from outside.

## Cable pull escape release

In case of an emergency arising from a person being locked in, the entrance can be unlatched via a cable pull and trigger an emergency stop at the same time. This works also if the operator is not able to reach the escape route in time.

**Emergency!**

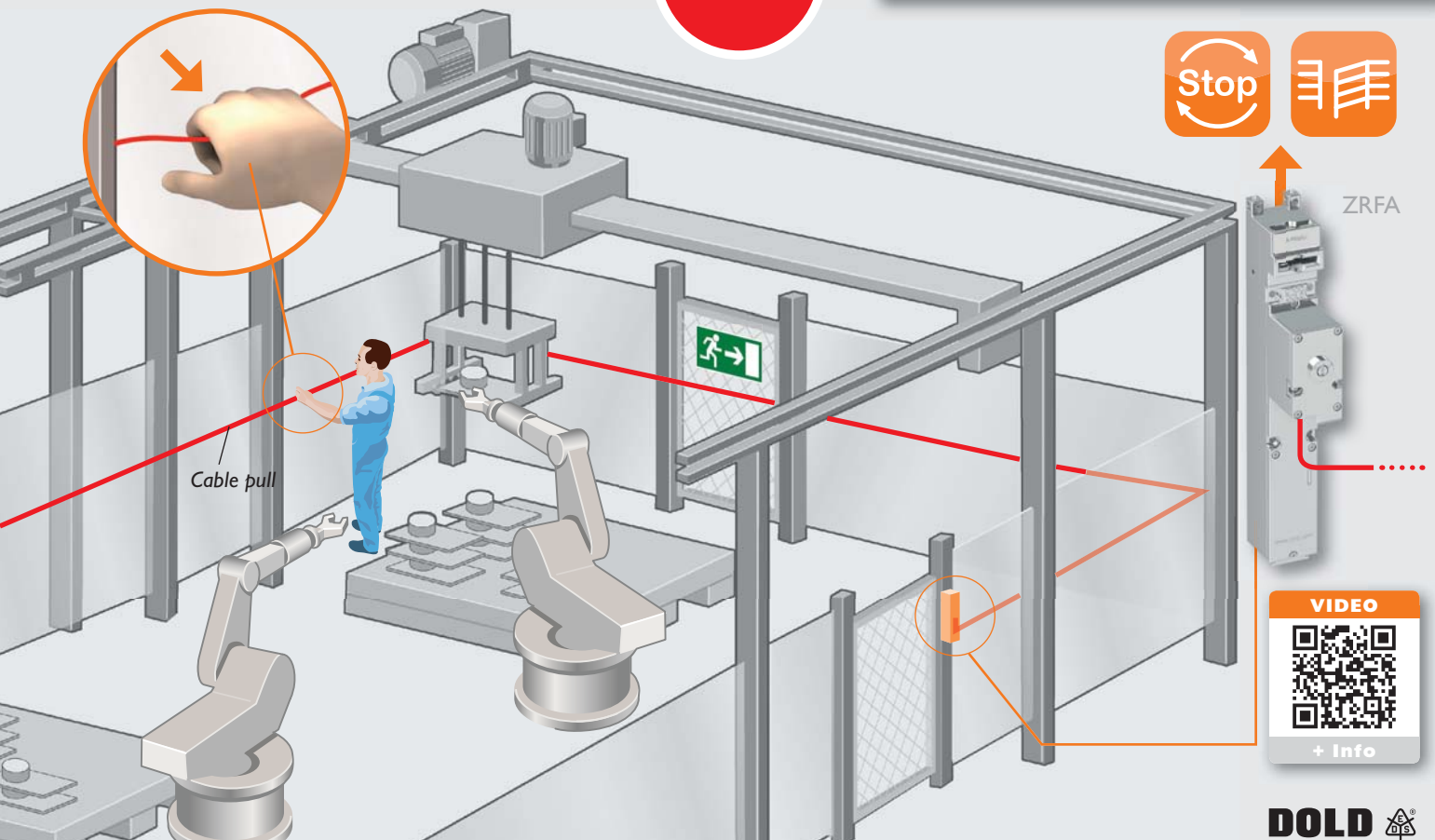



# SAFEMASTER STS - Simple combination

An interlocking unit with solenoid guard lock securely guards the main access door to a dangerous zone. An access door that is frequently used, could feature electric monitoring. Access doors used more rarely, and doors located in rugged areas such as outdoor areas of the facility can be secured with a purely mechanical or non wired stainless steel version.

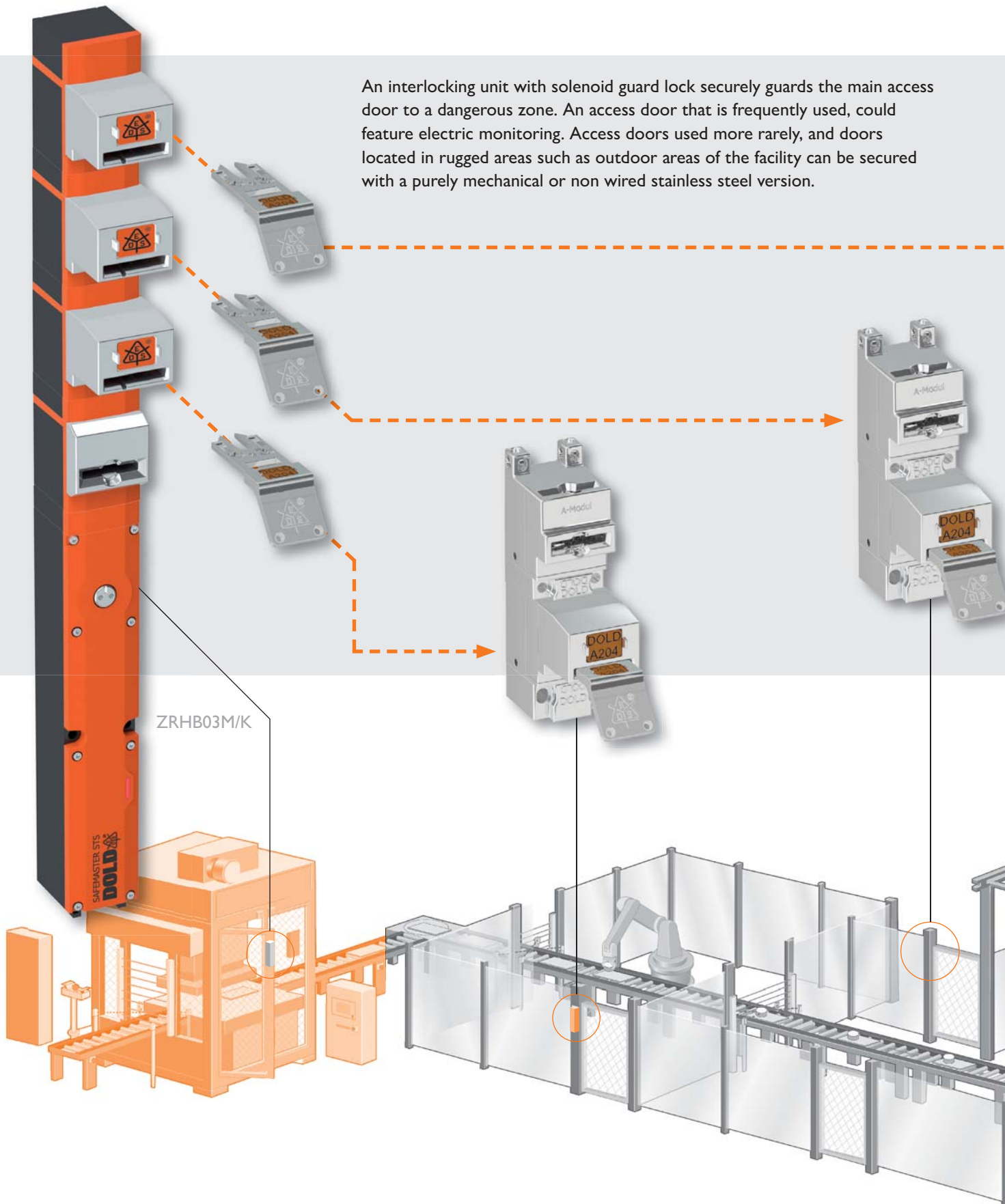



# Stainless steel and fibre reinforced polymer (FRP) design



## Integrating stainless steel solution

SAFEMASTER STS also offers the option of a combination of fibre reinforced polymer (FRP) and stainless steel design, for use in rugged environmental conditions. Thanks to its good cross compatibility, the system can be adapted to suite your specific application. For example, the FRP version can be used in your switch cabinet, with the stainless steel solution being used in extreme and rough handling areas.

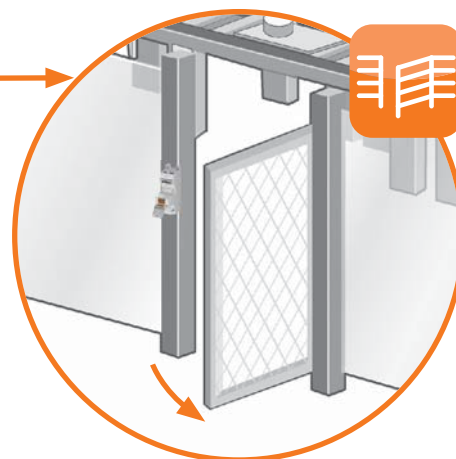
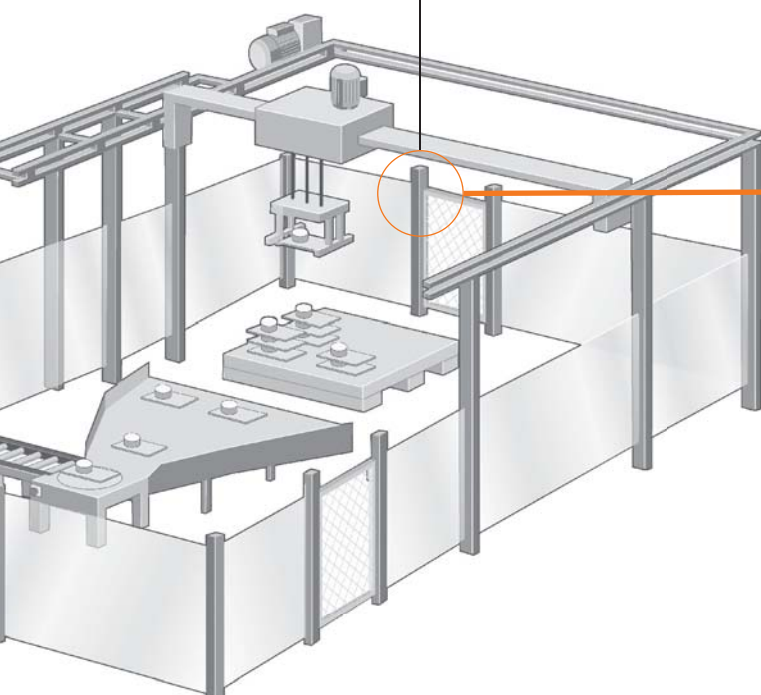
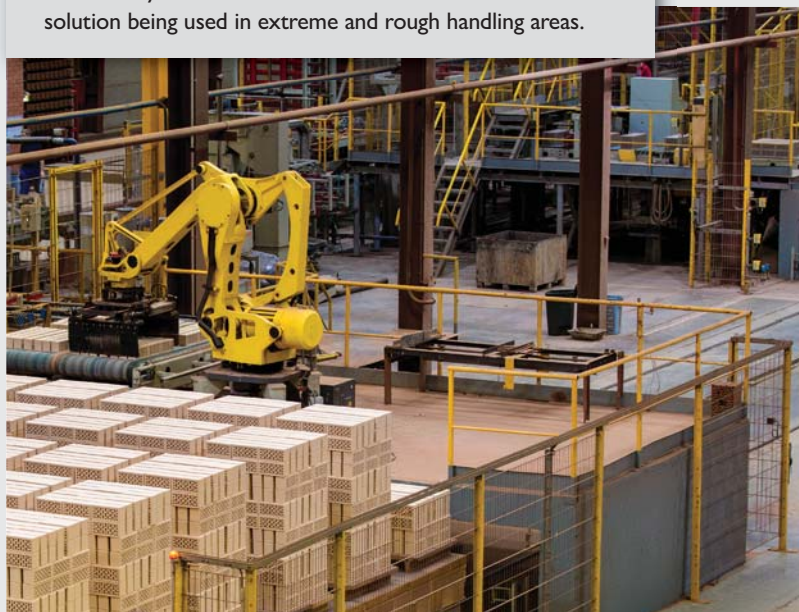

# Option module - Operating and command functions

The option module expands SAFEMASTER STS with various command, indication, and emergency stop functions. This turns the system into a true "control centre" from where command functions, status displays, release signals, main and maintenance access points can be controlled. The option module is form-fitting and can be installed directly underneath switches or solenoid lock units thus enabling direct command execution at the access points for machines and systems. The special multi-cable with plug-in connector ensures rapid and problem-free internal connection of the individual components. It is also possible to install the module as an independent command device.

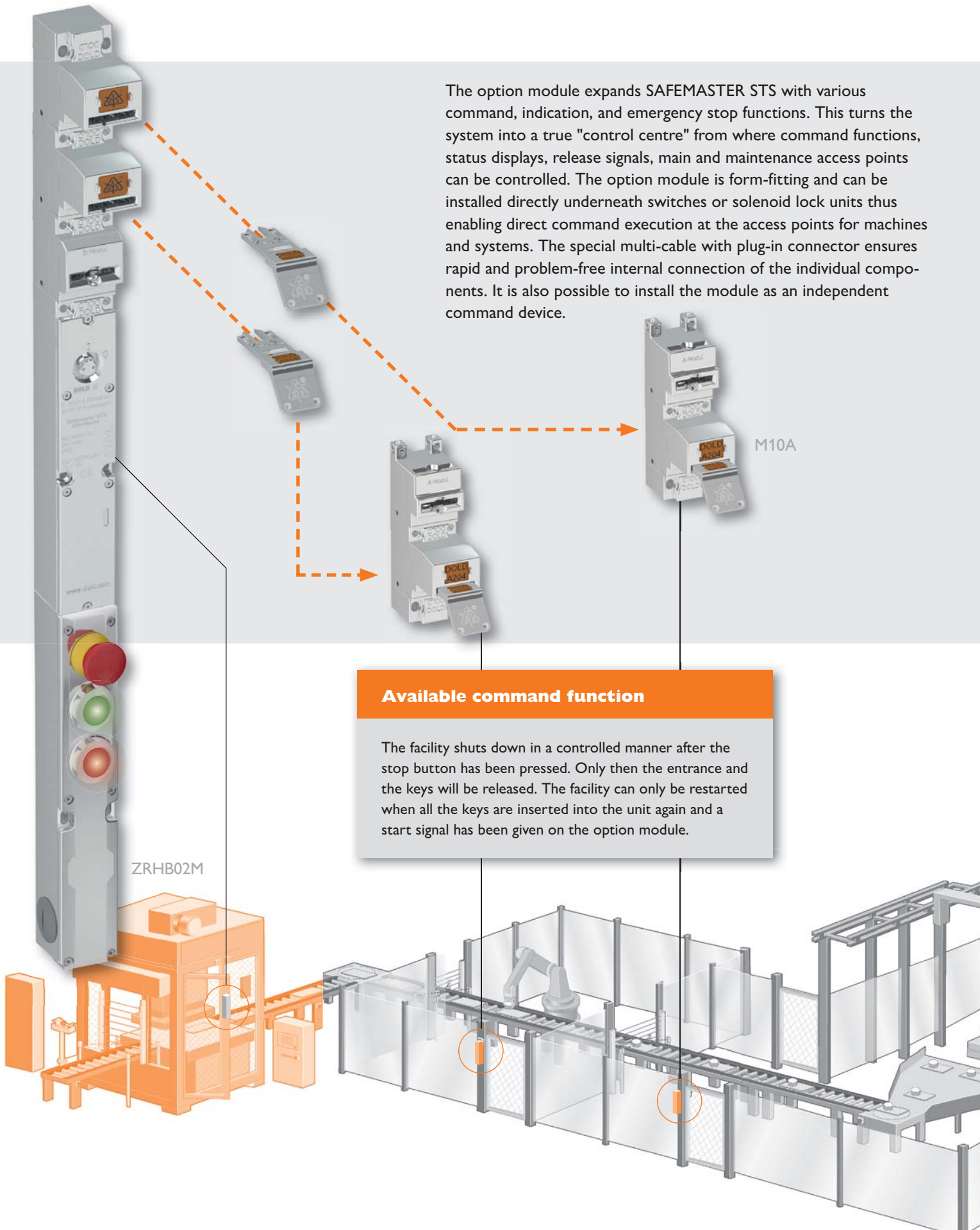

ZRHB02M

M10A

## Available command function

The facility shuts down in a controlled manner after the stop button has been pressed. Only then the entrance and the keys will be released. The facility can only be restarted when all the keys are inserted into the unit again and a start signal has been given on the option module.

# Complex requirement - Simple solution

## Cascading

If interlocking devices with potential-free contacts are used in complex or interlinked facilities, these are typically connected in series (cascading). This reduces the wiring, but errors may not be detected when multiple doors are opened. If multiple entry points must be opened at the same time in a cascade or series connection, then a fault exclusion is required to reach at least a performance level of PL d. With SAFEMASTER STS, individual units can monitor multiple entrances at the same time, with the advantage that no cascading, no associated decrease in performance level, and no fault exclusion is required. Since the system monitors itself mechanically, when using SAFEMASTER STS applications up to the highest safety level (PL e in accordance with EN ISO 13849-1) can be realised, and at the same time wiring content is reduced.

Zone 1

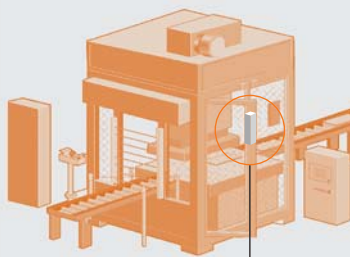

Zone 2

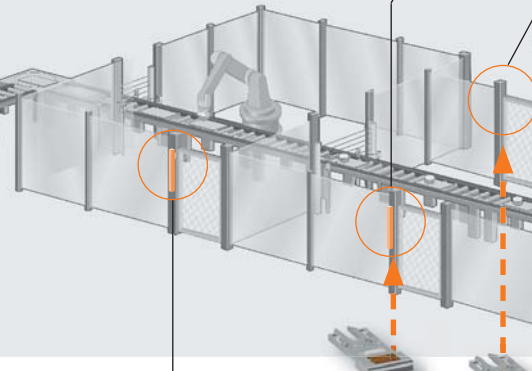

Zone 3

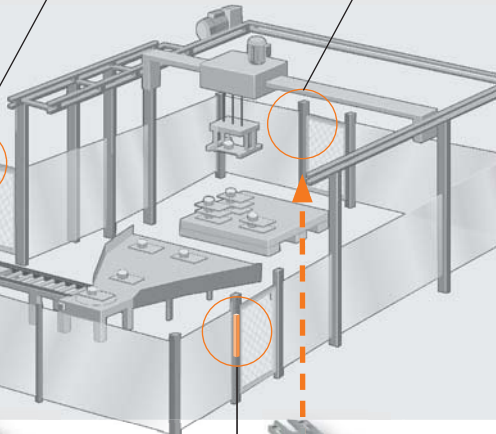

The option module can also be perfectly combined with the multifunctional safety module, SAFEMASTER M. Plants can be subdivided into zones, with individual SAFEMASTER STS units monitoring multiple entrances.

ZRHA

ZRHB01M

ZRHB02M

SAFEMASTER M

Zone 1

Zone 2

Zone 3





# Control Interlocking – Controlled shutdown

## Machine and facility monitoring

Flexible and highly efficient: With control interlocking, machine or facility shutdown is monitored by a higher level control unit, such as safety modules, speed and standstill monitors or safety controllers. This means the system is shut down in a controlled manner and the access to the system is enabled. SAFEMASTER STS is suitable for applications up to the highest safety level (PL e in accordance with EN ISO 13849-1), and can be integrated into both centralised and decentralised control concepts.



ZRHB01M/K

M10B03M/K

M10BM/K

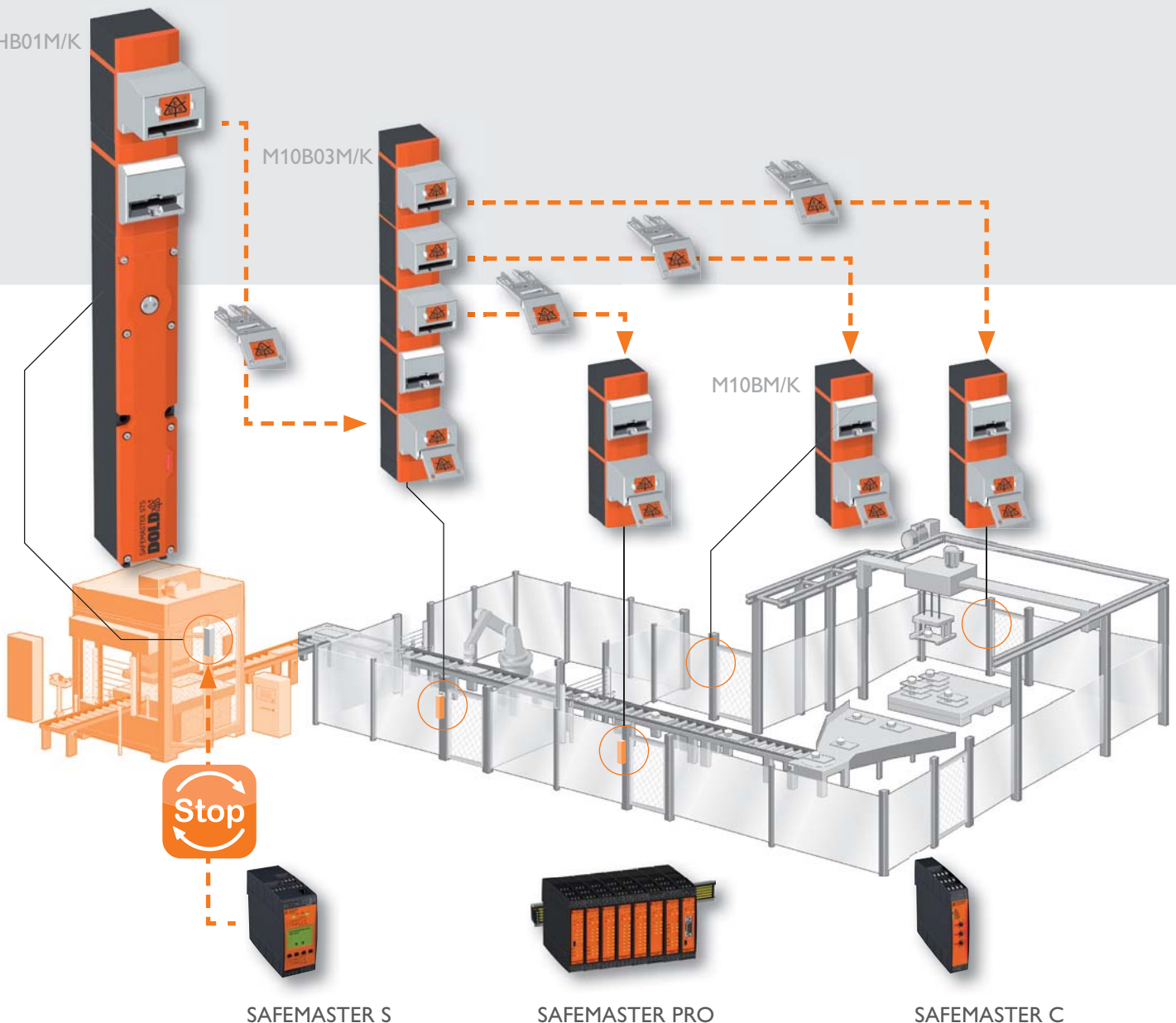



# Power Interlocking – Safely interlocking the load circuit breaker

Power Interlocking includes a load-break switch integrated into the SAFEMASTER STS system. This allows electric power to be securely shut down and locked off. This is achieved without a separate electrical or electronic control level.

Power Interlocking from the SAFEMASTER STS series forces the disconnection of the energy source by turning off the load circuit breaker before entering the facility. Only after the load circuit breaker is turned off the key to the integrated locking unit can be removed. Pulling the key mechanically locks the load circuit breaker in the off position. This stops the system from restarting. Once the key is released, another, purely mechanically locked accesses, can be operated. This significantly reduces installation and assembly work. The two-channel construction of the system allows integration into the emergency stop circuit. This makes it possible to achieve safety levels up to PL e, category 4 in accordance with EN ISO 13849-1. Power Interlocking is suitable for currents up to 800 A, and guarantees safe interlocking, even in the event of auxiliary and control circuit failure.

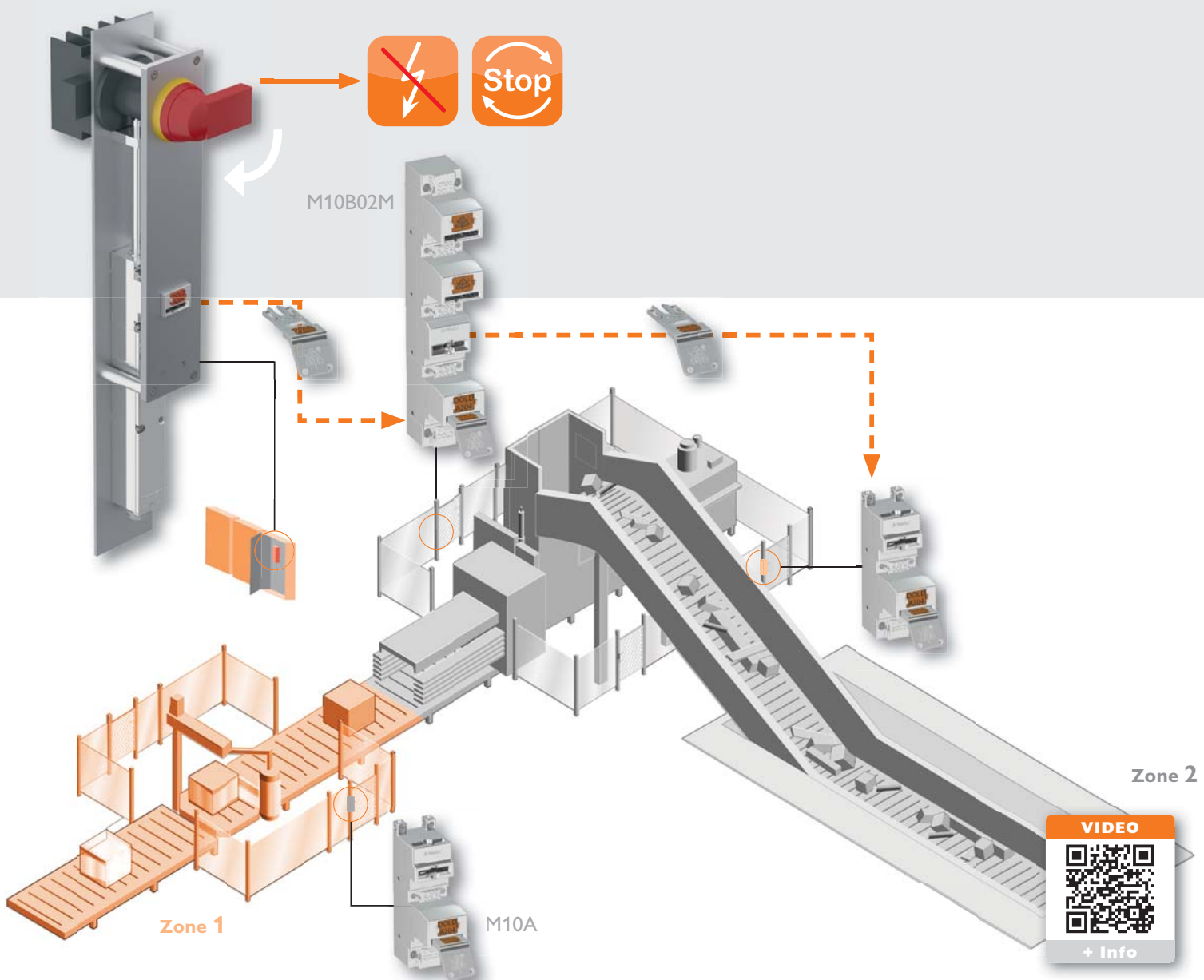

# SAFEMASTER STS – The components

## Key modules



## Accessories



## Actuator modules



## Actuators



## Padlock modules (LOTO)



## Solenoid lock modules



## Switch modules



## Command devices



# Multiple functional elements

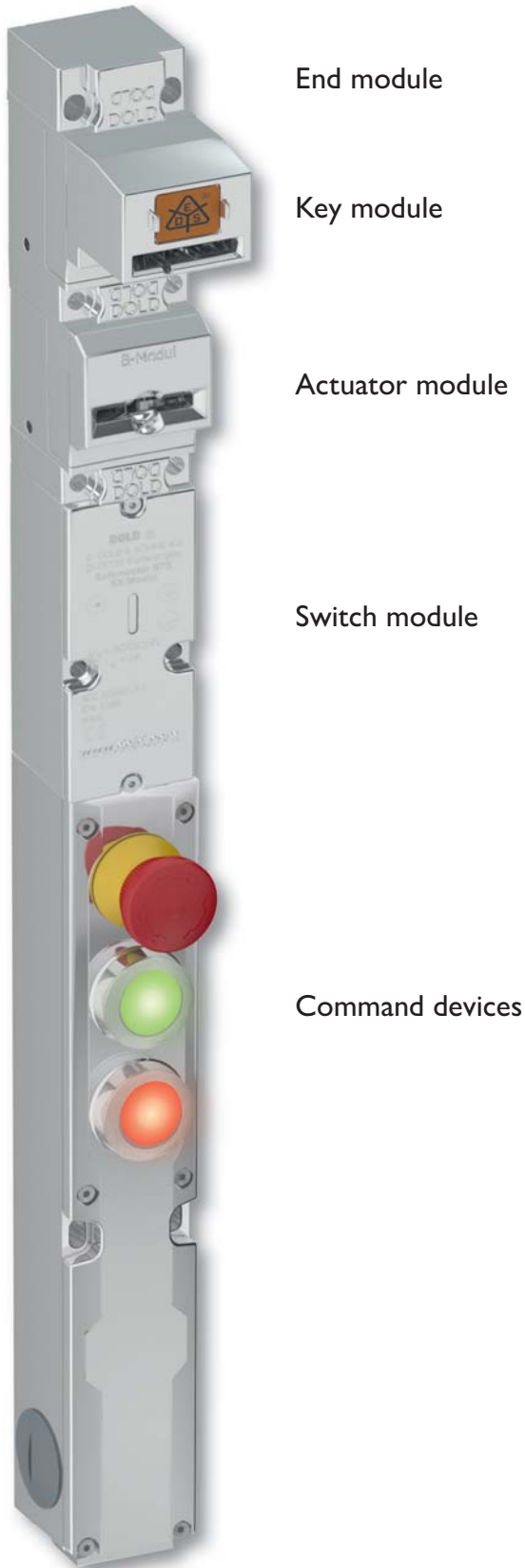

## Individual configuration – for an optimal design for your system

The **key module** monitors, for example, the release or locking of a safety door, using personal keys. This feature makes it possible to require a specific order of operations from which workers may not deviate.

The **padlock module** (LOTO) offers additional safety functions and serves to release or lock functions. This can be implemented with a padlock inserted to a key that cannot be removed.

**Actuator modules** guarantee safe access, for instance to a protective cover or door. The actuator module, together with the actuator, monitors the placement of two moving components of a protective device. In combination with other modules, they can create output signals, keep access doors closed, and force processes.

**Solenoid lock modules** ensure that protective doors and other safety guards remain closed as long as there is a hazardous situation or a danger of injury to persons. Access is only granted once a release signal is present.

The **switch module** serves, for instance, to secure moveable safety guards. When the safety guards are opened, hazardous movements must be immediately turn off by the switch module and secured against restart.

**Command devices** enable safety doors to be monitored on machines and systems. They expand switch modules and solenoid lock modules with additional command functions in order to control main access points and maintenance access points for example.

**Accessory parts**, such as end module M or bayonet fittings, are used to connect or complete the SAFEMASTER STS Module. They also serve to flexibly mount the complete functional unit.

All functional modules can be mounted in 4 positions, each rotated by 90°. You can find further information on the individual modules on [www.dold.com](http://www.dold.com) or in the module data sheets.

# SAFEMASTER STS - The base units

Functions	Safety switch
Units with basic functions	 <p><b>SXBM/K SXA</b></p> <p><b>Switch with separat actuator</b> The contacts are operated when removing the actuator</p>
Units with mechanical guard lock function by means of a key	 <p><b>SX01BM/K SX01A</b></p> <p><b>Switch with separat actuator and forced key removal</b> The contacts are operated and the actuator is released when the key is removed</p>
Units with optional key release	 <p><b>SXB01M/K SXB01M</b></p> <p><b>Switch with separat actuator and optional key removal</b> The contacts are operated and the key can be removed when the actuator is removed</p>
Units without actuators	 <p><b>SX01M/K SX01M</b></p> <p><b>Key operated switch</b> The contacts are operated when removing the key</p>



## Safety switch with guard lock

## Mechanical guard lock units



### ZRHBM/K ZRHA

#### Switch with electro-mechanical guard lock and separat actuator

When the solenoid is operated, the solenoid contacts are switched, when the actuator is removed, the actuator contacts are operated



### M10BM/K M10A

#### Mechanical guard lock with separat actuator

The actuator can be removed after the key has been inserted



### ZRH01BM/K ZRH01A

#### Switch with electro-mechanical guard lock, separat actuator, and forced key removal

When the solenoid is operated, the solenoid contacts are switched, when the key is removed, the key contacts are operated and the actuator can be removed



### M11BM/K M11A

#### Mechanical guard lock with separat actuator and forced key removal

After the first key has been inserted, the second key and the actuator can be removed



### ZRHB01M/K ZRHB01M

#### Switch with electro-mechanical guard lock, separat actuator, and optional key removal

When the solenoid is operated, the solenoid contacts are switched, when the actuator is removed, the actuator contacts are operated and the key can be removed



### M10B01M/K M10B01M

#### Mechanical guard lock with separat actuator and optional key removal

If the first key has been inserted, the actuator must be removed, and the second key is released



### ZRH01M/K ZRH01M

#### Key-operated switch with electro-mechanical locking

When the solenoid is operated, the solenoid contacts are switched, when the key is removed, the key contacts are operated







### M11M/K M11M

#### Key exchange unit

The second key can be removed after the first key has been inserted

# SAFEMASTER STS -

## The base units

Functions	Mechanical guard lock units with interlock	
Units with basic functions		<p><b>RXK01M/K</b> <b>RXK01M / RX10A</b></p> <p><b>Mechanical guard lock with electrical monitoring of actuator or key position with separat actuator</b></p> <p>RXK01M: The actuator can be removed after the key has been inserted on top. RX10A: The actuator can be removed after the key is inserted</p>
Units with mechanical guard lock function by means of a key		<p><b>RXK11M/K</b> <b>RXK11M / RX11A</b></p> <p><b>Mechanical guard lock with separat actuator and forced key removal</b></p> <p>RXK11M: After the first key has been inserted on top, the second key and the actuator can be removed RX11A: After the first key has been inserted on top, the second key and the actuator can be removed, operating the contacts</p>
Units with optional key release		<p><b>RX10K01M/K</b> <b>RX10K01M</b></p> <p><b>Mechanical guard lock with monitoring of second key</b></p> <p>After the first key has been inserted on top, the actuator and then the second key can be removed; only then will the contacts be operated</p>
Units without actuators		<p><b>RX11M/K</b> <b>RX11M</b></p> <p><b>Key exchange unit with electrical monitoring</b></p> <p>After the first key is inserted above, the second key can be removed, thereby operating the contacts</p>

## Electro-mechanical guard lock units with electro-mechanical release



### YRKKM/K YRXKM

#### Switch with separate actuator and actuator insertion blocking

The actuator can be removed at any time, operating the actuator contacts. When the solenoid is triggered, the solenoid contacts are operated and the actuator can be inserted; this operates the actuator contacts



### YRX10BM/K YRX10A

#### Mechanical guard lock with separate actuator and electro-mechanical release

The key can only be inserted if the solenoid is triggered; this operates the solenoid contacts

Inserting the key operates the key contacts and the actuator can be removed



### YRX10B01M/K YRX10B01M

#### Mechanical guard lock with separate actuator and electro-mechanical release, and optional second removable key

The first key can only be inserted if the solenoid is triggered; this operates the solenoid contacts. Inserting the key operates the key contacts. Then, the actuator and the second key can be removed



### YRX11M/K YRX11M

#### Key exchange unit with electromechanical release signal

After a release signal is present, the first key can be inserted and the second key removed

## Command devices



### TTN

#### Command device with two command functions and an emergency stop switch

Plug-in connection technology with double-spring clamp terminals for wires up to 1.5 mm<sup>2</sup>



### TTT

#### Command device with three command functions

Plug-in connection technology with double-spring clamp terminals for wires up to 1.5 mm<sup>2</sup>



### WTT

#### Command device with a selector switch (2 positions) and two command functions

Plug-in connection technology with double-spring clamp terminals for wires up to 1.5 mm<sup>2</sup>



### WTN

#### Command device with one selector switch, one command function, and one emergency stop switch

Plug-in connection technology with double-spring clamp terminals for wires up to 1.5 mm<sup>2</sup>

# Four safety concepts ...

## Mechanical system without key exchange unit

None of the entrances are wired. Additionally, safety keys or padlock modules can be added to protect against being locked in.

All keys are centrally located outside of the installation, suitable for facilities with few entrances.

### Optional:

- Personal key
- Authorisation key
- Padlock module
- Escape release
- Feedback contact

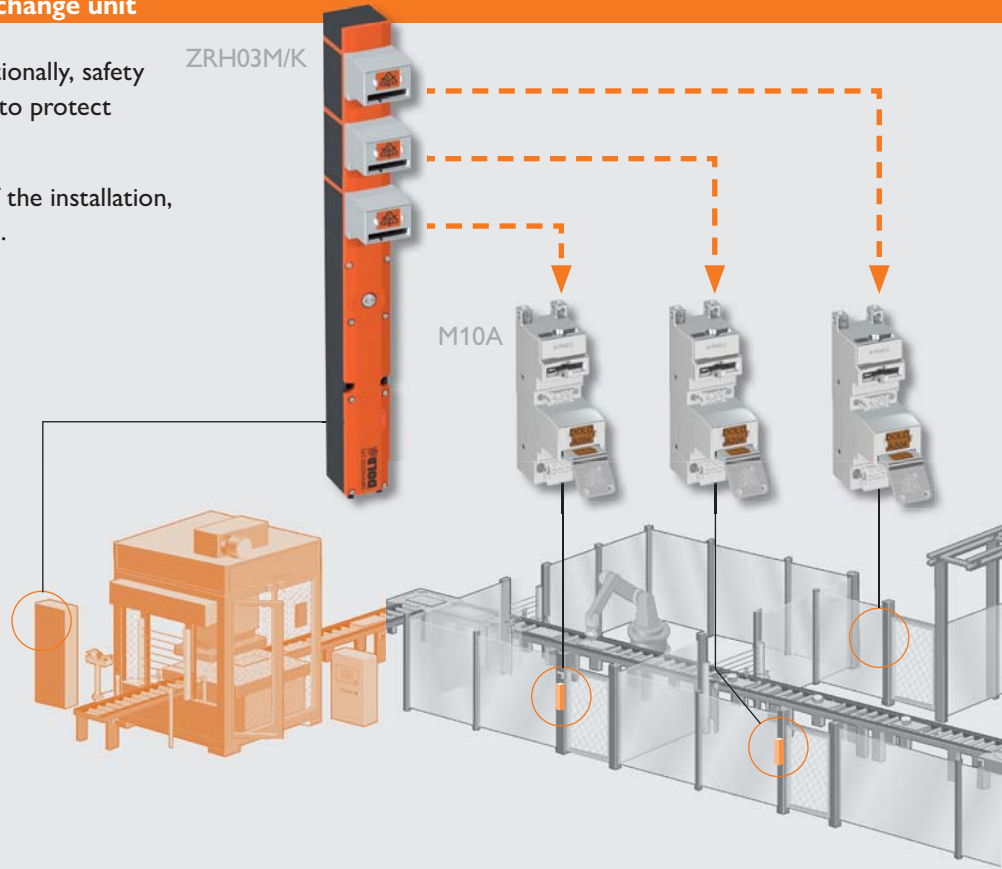

## Mechanical system with key exchange unit

None of the entrances are wired, if desired it is possible to only open one door, or multiple doors simultaneously.

If only one door is directly opened, then it is ensured that the remaining doors will stay closed.

The key exchange unit is located afield, while the locking switch is monitored by the control system.

### Optional:

- Personal key
- Authorisation key
- Padlock module
- Escape release
- Feedback contact

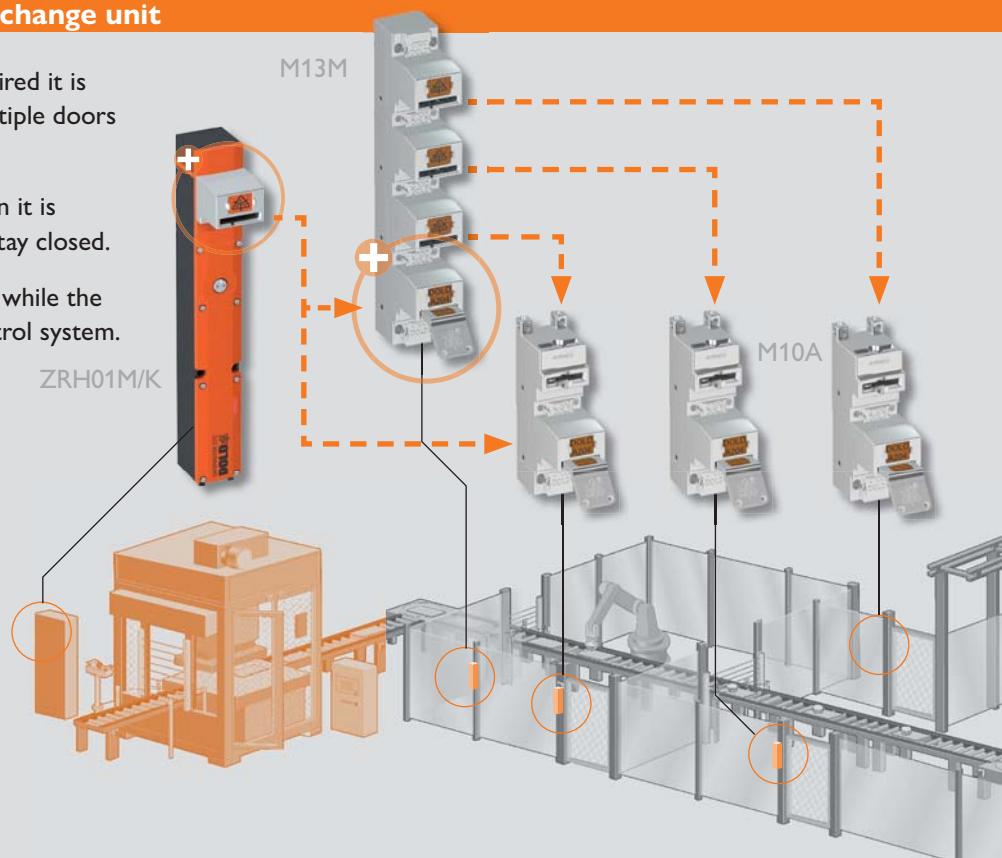



# for maximum protection in all areas

## Mechanical system with integrated key exchange unit

None of the entrances are wired, the main entrance must be opened first. There is also the optional possibility of directly opening one of the maintenance gates. If only one door is directly opened, then it is ensured that the remaining doors will stay closed.

### Optional:

- Personal key
- Authorisation key
- Padlock module
- Escape release
- Feedback contact

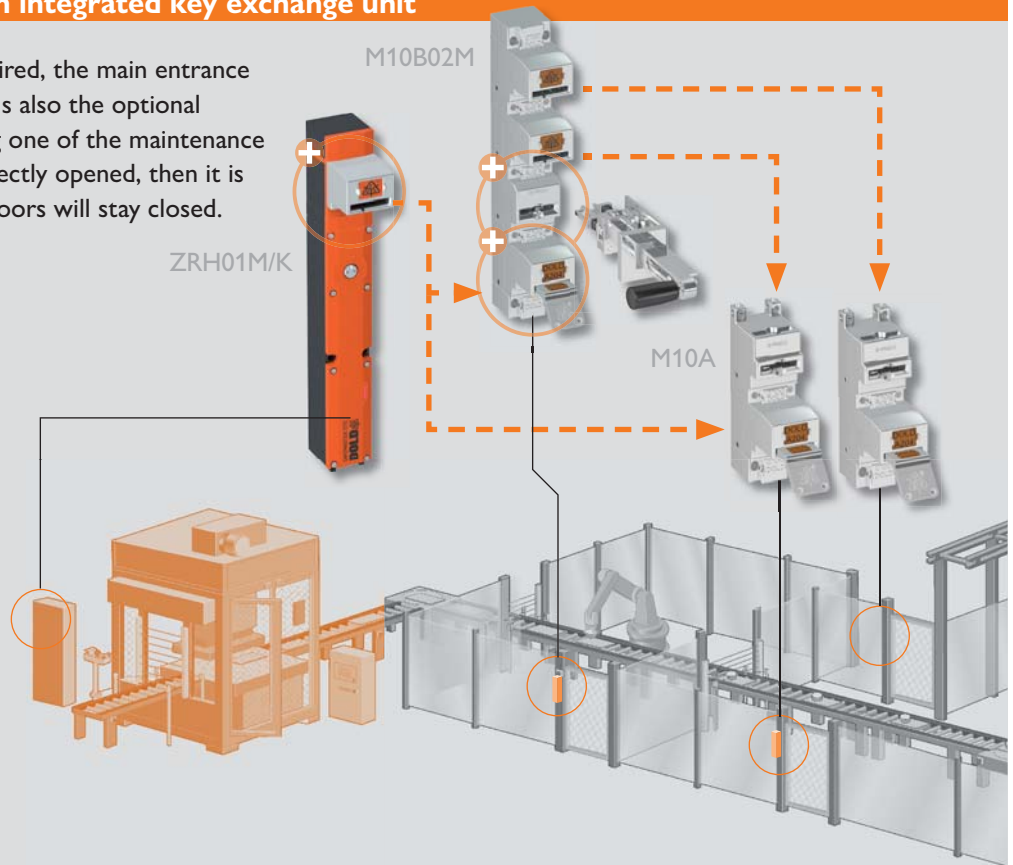

## Hybrid system

The main entrance is electro-mechanically monitored and releases the keys of the maintenance doors.

It is quicker to operate than all other mechanical systems, and offers the option of integrating an additional electro-mechanical escape release and the Option Module directly on the main entrance.

### Optional:

- Personal key
- Authorisation key
- Padlock module
- Escape release / Emergency release
- Cable pull escape release
- Feedback contact
- Option module

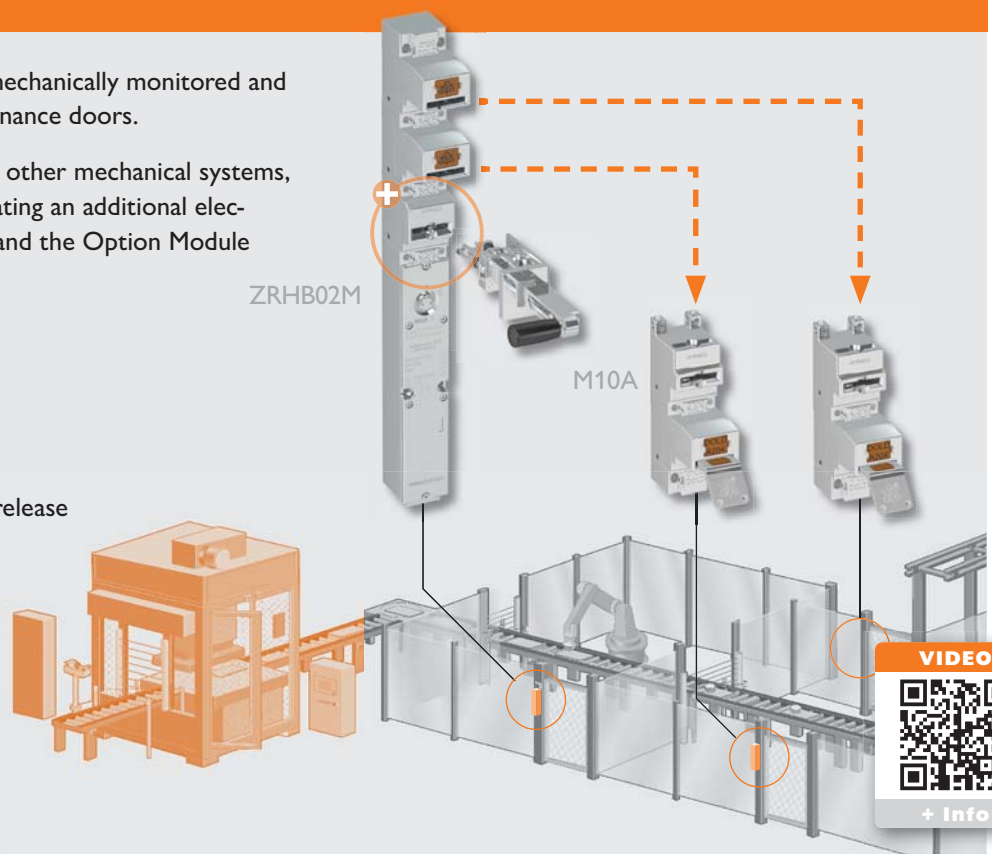

# Comprehensive range of accessories - Simple installation

The various accessory components connect the base module to a wide range of different locking units. This means you can create a wide range of different combinations with just a few individual components – specifically adapted to your application.

SAFEMASTER STS units can be delivered either pre-assembled on a mounting or front plate, or with pre assembled wiring harnesses and plugs.



## Mounting and front plate

Mounting or front plates are made from high-quality, robust stainless steel. The (threaded) holes in these plates allow for a wide variety of installation options. The plates are available in a range of sizes, and are suitable for installation on fences and system profiles, as well as front panel mounted installation of STS units in switch cabinets.



*The front plate facilitates panel mounted installation of SAFEMASTER STS units, for instance in switch cabinets or machine enclosures.*



## Robust plug connection with cable

Pre assembled cables, available in different lengths, allow quick and easy connection of safety switches or guard locks from the SAFEMASTER STS series, optionally also via round plug connectors.



# Different actuators - Wide variety of solutions

## J, C, T actuators

Actuators work with the actuator module to monitor the position of two movable components in a safety guard. SAFEMASTER STS offers different actuators for a variety of application scenarios. Whether you need a flexible, robust, self-adjusting, or coded actuator: SAFEMASTER STS offers the perfect solution for your application.

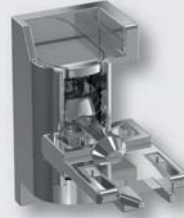

J actuator - self-adjusting, 4 degrees of freedom, robust, and codable



C actuator - flexible, adjustable, robust, and codable



T actuator - stable, simple, and codable



## CS actuator and CS mounting plate

The CS actuator consists of a flexible C actuator and a manually operated sliding latch. It is used as a door lock on revolving doors, and is designed for applications with high shearing and traction forces, so as to prevent most breakages caused by overloading.

## Coding

SAFEMASTER STS actuators and actuator modules can be coded as a safeguard against operator manipulation. This function can also be retrofit.

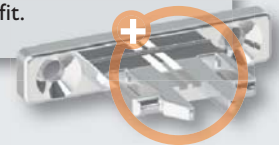

## CW bolt actuator

The CW bolt actuator combines a door handle and door latch in one, and is especially well suited to secure safety doors exposed to high forces, such as when the door is slammed. The "floating" installation transfers forces from the interlocking unit into the bolt actuator. The robust and ergonomic handle allows safety doors to be opened and closed easily and is ideally suited for use in rugged ambient conditions. The CW bolt actuator can be installed on either the left or right side of a safety door without additional assembly work. In addition, a variety of options and attachment mountings are available.



# Typical applications – FRP version



Automotive industry



Process automation

SAFEMASTER STS Designer

1. Projekt 2. Systemeinheit 3. Schlüsselauflagen 4. Stückliste 5. Gefahrenskizze

Systemeinheiten

YRH 10 D

341 mm

D

10

YRH

Betätiger wählen

- CK-Betätiger
- CKS-Betätiger

Elektrische Module

Ruhestrom  Arbeitsstrom

Zuhaltemodule

YRX

YRH-Modul

SAFEMASTER STS D

1. Projekt 2. Systemeinheit

Systemeinheiten

- ✓ ZRH 01 A
- ✓ M 11 A
- ZRH
- ✓ ZRH 01 A
- ✓ M 11 A

Schaltermo

Neuauflagen



Logistics management



Railway industry





Automation technology

**DOLD**

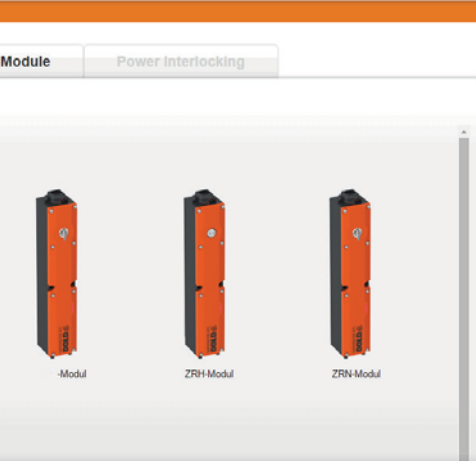

Packaging industry

Designer

**DOLD**

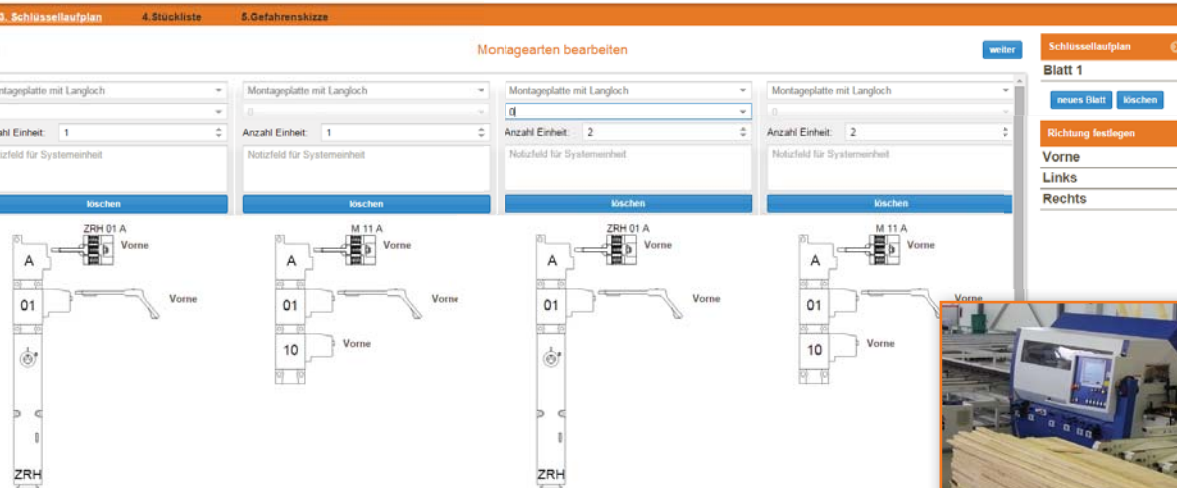

Woodworking industry

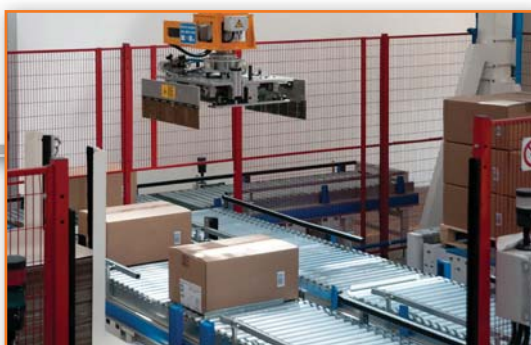

Materials handling technology



# For use in rugged conditions – Stainless steel version



Stone processing



Steel works

SAFEMASTER STS Designer

1. Projekt 2. Systemeinheit 3. Schlüssellaufplan 4. Stückliste 5. Gefahreskizze

YRH 10 D

341 mm

D

10

YRH

Betätiger wählen

- CK-Betätiger
- CKS-Betätiger

Elektrische Module

Ruhestrom  Arbeitsstrom

Zuhaltemodule

YRX

YRH Modul

ZRX-Modul

Schaltermodule

Mechanische

SAFEMASTER

1. Projekt 2. Systemeinheit

Systemeinheiten

- ✓ ZRH 01 A
- ✓ M 11 A
- ✓ ZRH 01 A
- ✓ M 11 A

hinzufügen



Construction materials industry



Food industry



Railway industry



Module Power Interlocking



Animal enclosures

STS Designer



1. 2. 3. Schlüsselaufplan 4. Stückliste 5. Gefahrenskizze

Blatt 1 Montagearten bearbeiten

<p>Montageplatte mit Langloch</p> <p>Anzahl Einheit: 1</p> <p>Notizfeld für Systemeinheit</p> <p>löschen</p>	<p>Montageplatte mit Langloch</p> <p>Anzahl Einheit: 1</p> <p>Notizfeld für Systemeinheit</p> <p>löschen</p>	<p>Montageplatte mit Langloch</p> <p>Anzahl Einheit: 2</p> <p>Notizfeld für Systemeinheit</p> <p>löschen</p>	<p>Montageplatte mit Langloch</p> <p>Anzahl Einheit: 2</p> <p>Notizfeld für Systemeinheit</p> <p>löschen</p>
--	--	--	--

weitere Schlüsselaufplan Blatt 1

neues Blatt löschen

Richtung festlegen

Vorne Links Rechts



Lumber industry



Recycling industry

VIDEO

+ Info



# Our experience. Your safety.

## SAFEMASTER - The right solution for every application.

### Innovative safety concepts

As a solution provider for safe automation and electrical safety, DOLD offers a comprehensive product portfolio from a single source. Our SAFEMASTER solutions have been successfully used for many decades around the world.

From single function safety switching devices for simple safety applications through to multifunction, modular safety systems, DOLD develops tailor-made solutions for your industry and applications.

We would be happy to provide you with information about further safety solutions.



### SAFEMASTER C

The multifunctional safety module UG 6970 from DOLD's SAFEMASTER C family monitors two independent safety functions. Select any functions from the basic range of functions emergency stop, safety door, two-hand control, safety mat/safety strip, antivalent switches and light barrier.



### SAFEMASTER S

Our solutions for secure drive monitoring utilise a combination of safe speed, standstill, or frequency monitoring, with or without external sensors, to increase productivity and safety.



### SAFEMASTER PRO

The modular and configurable SAFEMASTER PRO safety system monitors all safety circuits of your machinery and installations – in a simple, flexible and safe manner. The number of inputs and outputs of the central control unit can be upgraded via extension modules at any time. Now also featuring safe speed monitoring and dynamic program realization.



### SAFEMASTER W

The emergency stop system and radio-controlled enabling switch in the SAFEMASTER W series can be used to wirelessly shut down hazardous movements in a fraction of a second. The Wireless Safety System thus ensures maximum freedom of movement for the operating and maintenance personnel.



**E. Dold & Söhne GmbH & Co. KG**  
Bregstraße 18 • D-78120 Furtwangen  
T +49 7723 654-0 • F +49 7723 654-356  
dold-relays@dold.com • www.dold.com