

# PCB relays

Printed circuit board relay  
Monostable  
OA / OW 5668

Translation  
of the original instructions

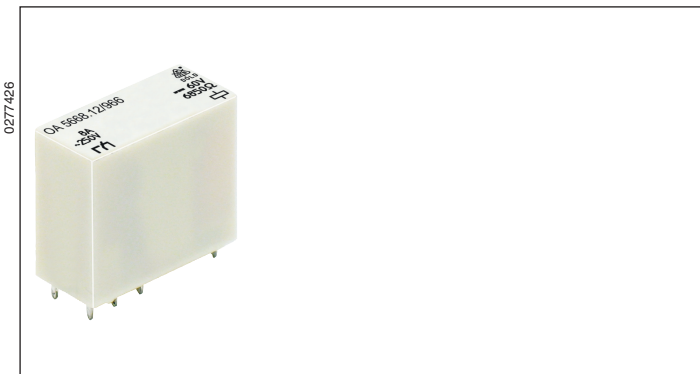

- According to EN 61810-1
- Clearance and creepage distances:  
Contact - coil  $\geq 8$  mm
- High dielectric strength  $\geq 4$  kV
- High mechanical service life
- High temperature range - 40 ... + 75 °C
- As option wash proof RT III

## Applications

- Control technique
- Interface

## Technical Data

<b>Relay type</b>	OA/OW 5668
<b>1.0 Relay coil</b>	
1.1 Nominal voltage	DC 5, 6, 12, 20, 24, 48, 60, 110 V
1.2 Nominal consumption	Approx. 0.5 W
1.11 Voltage range	0.7 ... 2.0 $U_N$
1.3 Holding power (at 0.5 x $U_N$ )	Approx. 0.13 W
<b>2.0 Contacts</b>	
2.1 Contact arrangement	2 changeover contacts, optionally 2 NO or 2 NC
2.2 Contact material	AgSnO <sub>2</sub> + 0.2 $\mu$ m Au on request; AgNi + 0.2 $\mu$ m Au, AgNi + 5 $\mu$ m Au
2.3 Rated insulation voltage	AC 250 V
Switching voltage min./max.	AC/DC 10 V / DC 250 V, AC 400 V (AC/DC 100 mV / 60 V) <sup>4)</sup>
2.4 Limiting continuous current $I_{th}$	2 x 5 A (s. see operating voltage limit curve)
Switching current min./max.	10 mA <sup>3)</sup> 2 x 8 A together or 1 x 10 A (1mA / 0.3 A) <sup>4)</sup>
2.5 Switching power min./max.	2 x 3 VA / 2000 VA together or 1 x 2500 VA (1mVA / 7 VA) <sup>4)</sup>
Switching power min./max.	2 x 30 W / 160 W together or 1 x 200 W (1mW / 7 W) <sup>2) 4)</sup>
2.6 Switching capacity to EN 60947-5-1	
AC 15	NC: AC 230 V / 1 A NO: AC 230 V / 2 A
DC 13	NC: DC 24 V / 1 A NO: DC 24 V / 1 A
2.7 Electrical life	At 1 s On, 1 s Off (see contact service life)
at AC 230 V, 6 A cos $\varphi = 1$	1.5 x 10 <sup>5</sup> switching cycles
2.8 Switching frequency max.	20 switching cycles/s
2.9 Response time / Release time	Typically 12 ms / Typically 5 ms
2.10 Contact force	$\geq 10$ cN / $\geq 8$ cN
<b>3.0 Other</b>	
3.1 Mechanical life	$\geq 50$ x 10 <sup>6</sup> switching cycles
3.2 Temperature range	- 40 ... + 75 °C mounted without distance ( $I_{th} = 2$ x 5 A)
3.3 Degree of protection	Solder line proof RT II as option wash proof RT III
3.5 Vibration resistance	10 ... 55 Hz; 0,35 mm Amplitude; max 5 g EN 60068-2-6
3.6 Climate resistance	40 / 075 / 04 (climate catgory); A/B/D EN 60 068-1

<sup>1)</sup> I on / I off

<sup>2)</sup> See limit curve for arc-free operation

<sup>3)</sup> Typical values

<sup>4)</sup> Values for AgNi -Contacts + 5  $\mu$ m Au

## Technical Data

3.8	Insulation acc. to IEC 60664-1, EN 50178	
	Rated insulation voltage	AC 250 V
	Pollution degree	2
	Overvoltage category	III
	Test voltage	
	Contact-coil (1 min)	≥ AC 4 kV eff.
	Contact-contact (1 min)	≥ AC 2.5 kV eff.
	Transient voltage	
	Contact-coil (1.2 - 50 μs)	≥ 6 kV
	Clearance and creepage distances	
	Contact-coil	≥ 8 mm
3.9	Weight	35 g
<b>4.0 Packing</b>		
4.1	On cardboard in slipcase	56 pieces
4.2	In case package	280 pieces
<b>5.0 Solder method</b>		
5.1	Solder method /-temperature /-duration	Wave soldering / 260 °C / 5 s

## Design versions

U <sub>N</sub> (DCV)	Voltage range (DC V)	R <sub>Coil</sub> Ω±10%	Design version OA / OW	
			.12	.02
5	3.5 ... 10.0	50	941	571
6	4.2 ... 12.0	70	942	572
12	8.4 ... 24.0	270	943	573
20	14.0 ... 40.0	820	949	578
24	16.8 ... 48.0	1 100	944	574
48	33.6 ... 96.0	4 400	945	575
60	42.0 ... 120.0	6 850	946	576
110	77.0 ... 220.0	20 000	947	577

## Ordering Example

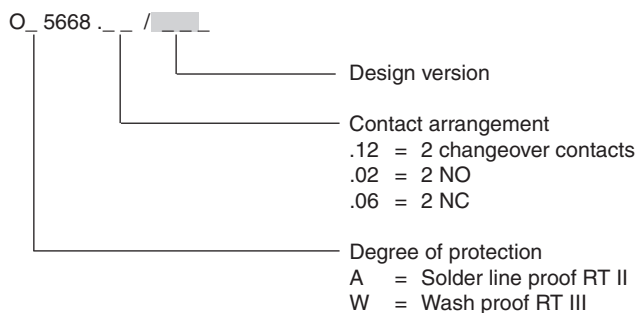

## Notes

For the use and processing of our PCB relays, please refer to the **application and processing instructions** at [www.dold.com](http://www.dold.com)

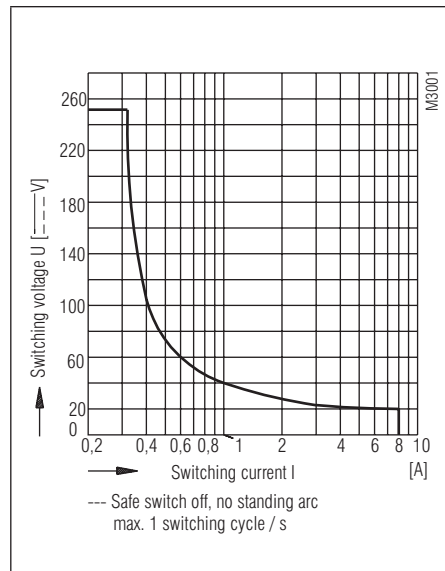
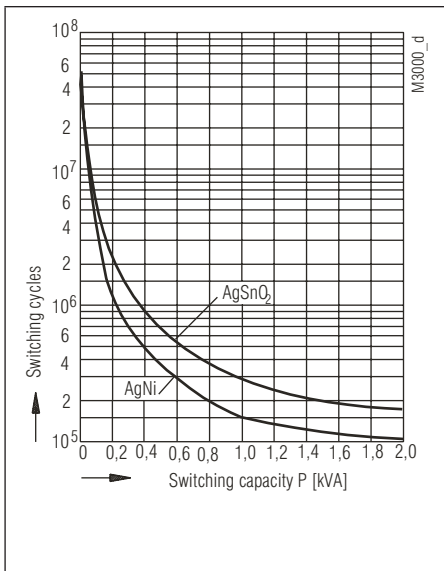
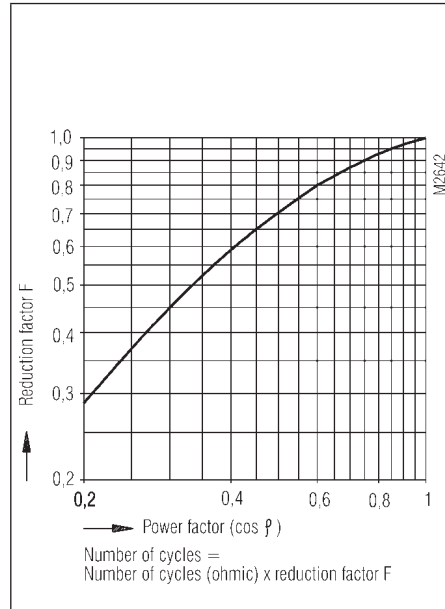
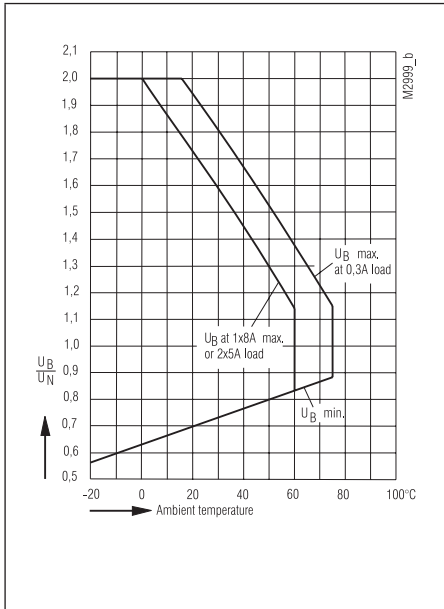

Drilling plan (solder side)

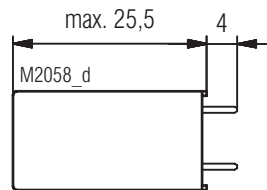
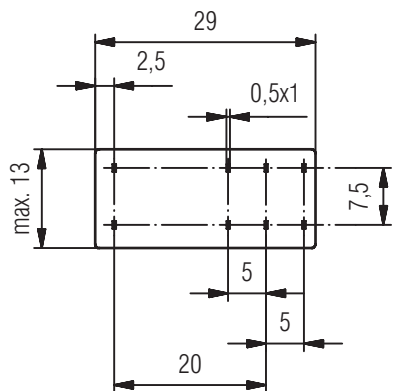
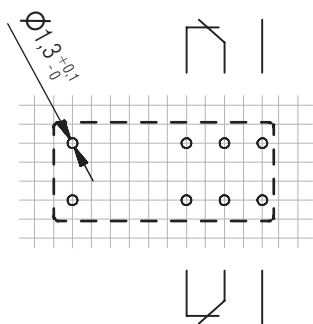

OA5668.12  
OW5668.12

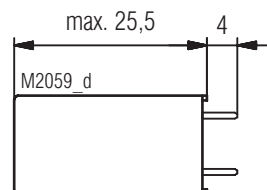
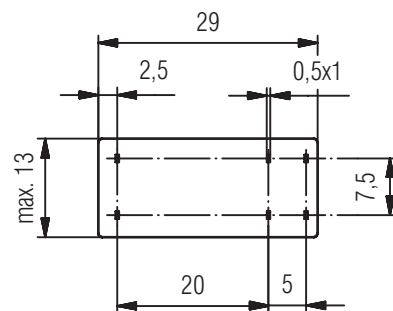
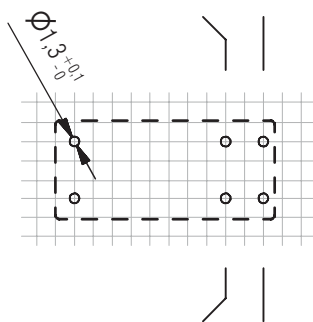

OA5668.02  
OW5668.02

Connection for basic grid dimensions 2.5 mm as well as 2.54 mm according to IEC/EN 60097 and IEC 60326 average

## Relay Socket incl. Fixing Clip

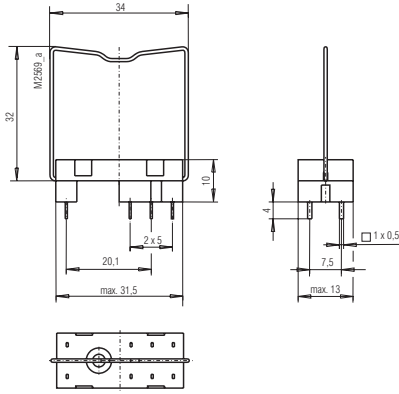

### Relay socket ET 1415.021

Article number: 0034769

### Fixing clip (wire) ET 1415.025

Article number: 0034770

### Fixing clip (plastic) ET 1415.026

Article number: 0047726

Packing: 100 pieces

## Function Modules

ET1415.913:	DC 24 V, with free-wheel diode and green LED
Article number:	0056828
ET1415.911:	DC 24 V, with free-wheel diode and red LED
Article number:	0055909
ET1415.912:	AC/DC 24 V, with varistor and green LED
Article number:	0055910
ET1415.924:	DC 60 V, with free-wheel diode and red LED
Article number:	0062552
Packing:	20 pieces

## Socket ET 1415.041 incl. Fixing Clip - Screw Terminals -

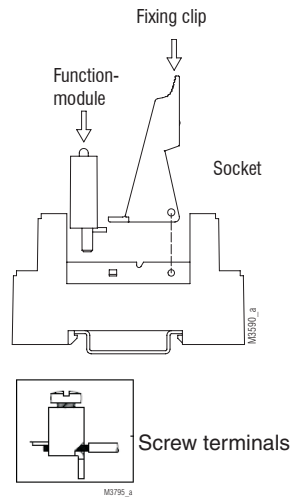

Article number: 0055571

**Temperature range:** - 25 ... + 70 °C

### Clearance and creepage distance

Rated impulse voltage /  
degree of protection

Input / output: 6 kV / 2 IEC 60664-1

Output / output: 4 kV / 2 IEC 60664-1

Overvoltage category: III

**Degree of protection:** IP 20 EN 60529

### Wire connection

Solid / stranded: 0.5 - 2.5 mm<sup>2</sup> (20-14 AWG)

Sleeved end: 0.14 - 2.5 mm<sup>2</sup> (26-14 AWG)

**Stripping length** 7 mm

**Wire fixing:** Screw terminals

**Fixing torque:** Max. 0.8 Nm

**Mounting:** DIN-rail EN 60715

**Weight:** Approx. 38.5 g

**Packing:** 10 pieces

## Dimensions

**Width x height x depth:** 15.8 x 75 x 69.0 mm

### Socket ET 1415.044 incl. Fixing Clip - Screw Terminals -

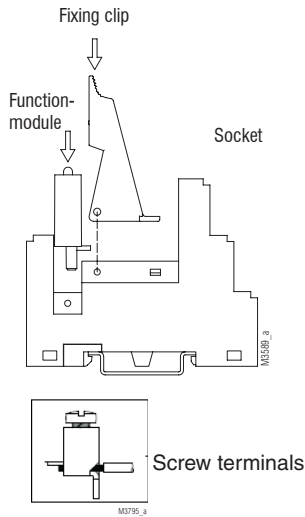

- Incl. safe separation between coil and contacts according to DIN EN 60947-1, DIN EN 61140

Article number: 0059274

**Temperature range:** - 25 ... + 70 °C

**Clearance and creepage distance**

Rated impulse voltage / degree of protection

Input / output: 6 kV / 2 IEC 60664-1

Output / output: 4 kV / 2 IEC 60664-1

Overvoltage category: III

**Degree of protection:** IP 20 EN 60529

**Wire connection**

Solid / stranded: 0.5 - 2.5 mm<sup>2</sup> (20-14 AWG)

Sleeved end: 0.14 - 2.5 mm<sup>2</sup> (26-14 AWG)

**Stripping length**

**Wire fixing:** Screw terminals

**Fixing torque:** Max. 0.8 Nm

**Mounting:** DIN-rail EN 60715

**Weight:** Approx. 43.5 g

**Packing:** 10 pieces

**Dimensions**

**Width x height x depth:** 15.8 x 75 x 75.0 mm

### Socket ET 1415.047 incl. Fixing Clip - Cage Clamp Terminals -

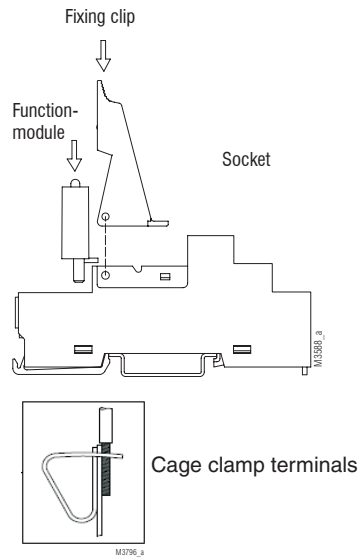

Article number: 0059270

**Temperature range:** - 25 ... + 70 °C

**Clearance and creepage distance**

Rated impulse voltage / degree of protection

Input / output: 6 kV / 2 IEC 60664-1

Output / output: 4 kV / 2 IEC 60664-1

Overvoltage category: III

**Degree of protection:** IP 20 EN 60529

**Wire connection**

2 x Solid / stranded: 0,5 - 1,5 mm<sup>2</sup> (20-16 AWG)

2 x Sleeved end: 0,14 - 1,5 mm<sup>2</sup> (26-16 AWG)

**Stripping length**

**Wire fixing:** Cage clamp terminals

**Mounting:** DIN-rail EN 60715

**Weight:** Approx. 42.0 g

**Packing:** 10 pieces

**Dimensions**

**Width x height x depth:** 15.8 x 97 x 75.5 mm



